

Ceramic Discrete Surface Mount Emitters and Detectors

SME/SMD Series

TYPICAL IRED PERFORMANCE CHARACTERISTICS (when solder mounted to PC board)

SME2470 Spectral Bandwidth

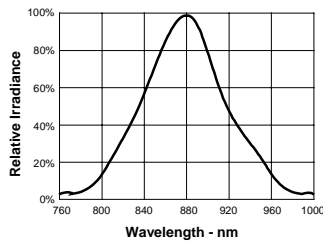

SME2470 Irradiance vs Angular Displacement

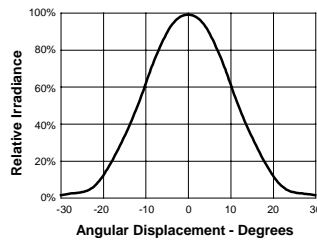

SME2470 Forward Current vs Forward Voltage

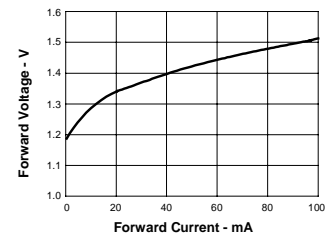

SME2470 Forward Voltage vs Temperature

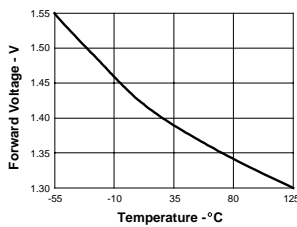

SME2470 Irradiance vs Temperature

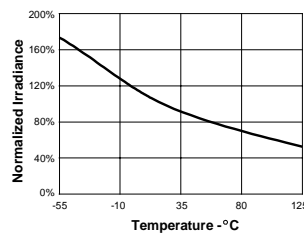

SME2470 Irradiance vs Forward Current

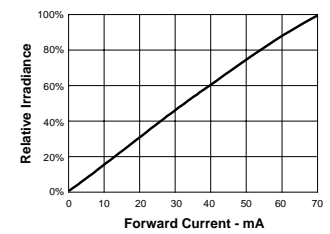

TYPICAL SMD2440 AND SMD2420 SERIES PERFORMANCE CHARACTERISTICS (when solder mounted to PC board)

SMD2440 and SMD2420 Spectral Responsivity

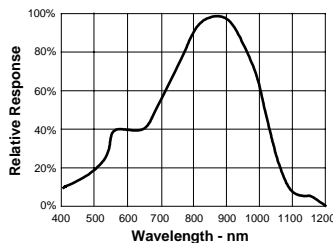

SMD2440 and SMD2420 Responsivity vs Angular Displacement

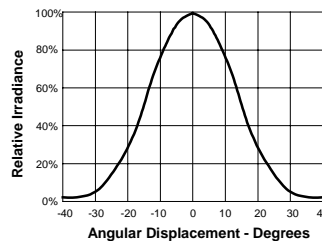

SMD2440 Dark Current vs Temperature

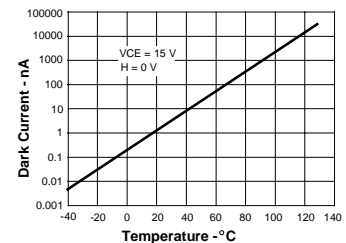

SMD2420 Dark Current vs Temperature

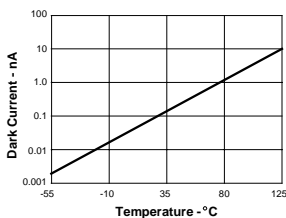

SMD2440 Collector Current vs Ambient Temperature

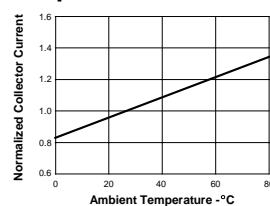

SMD2440 Non-saturated Switching Time vs Load Resistance

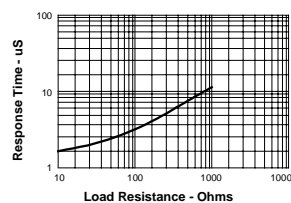

SME to SMD Coupling Characteristics

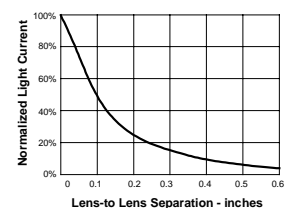

Ceramic SME/SMD Series

SMD2440 Switching Time Test Circuit

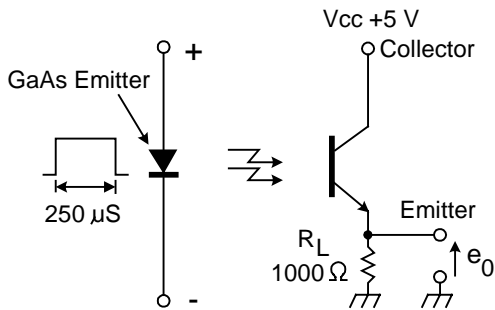

SMD2440 Switching Waveform

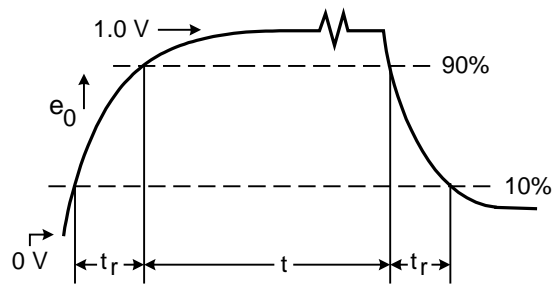

SMD2420 Switching Time Test Circuit

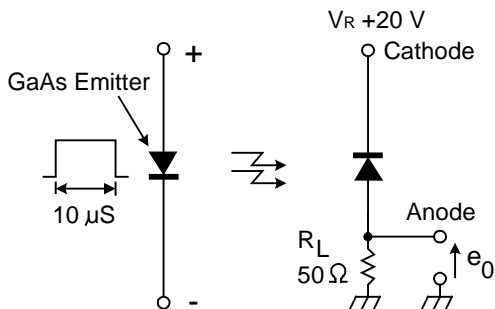

SMD2420 Switching Waveform

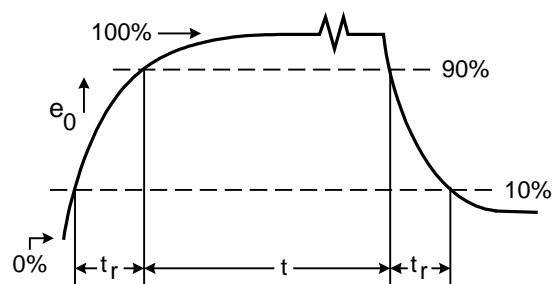

WARRANTY/REMEDY

Honeywell warrants goods of its manufacture as being free of defective material and faulty workmanship. Contact your local sales office for warranty information. If warranted goods are returned to Honeywell during that period of coverage, Honeywell will repair or replace without charge those items it finds defective. The foregoing is Buyer's sole remedy and is **in lieu of all other warranties, expressed or implied, including those of merchantability and fitness for a particular purpose.**

While we provide application assistance, personally, through our literature, and through the Honeywell website, it is up to the customer to determine the suitability of the product in the application.

Specifications may change at any time without notice. The information we supply is believed to be accurate and reliable as of this printing. However, we assume no responsibility for its use.

SALES AND SERVICE

Sensing and Control serves its customers through a worldwide network of sales offices and distributors. For application assistance, current specifications, or the name of the nearest Authorized Distributor, contact a nearby sales office or call:

TELEPHONE

1-800-537-6945 (USA)
1-800-737-3360 (Canada)
1-815-235-6847 (International)

FAX

1-815-235-6545 (USA)

INTERNET

www.honeywell.com/sensing
info@micro.honeywell.com

Honeywell

MICRO SWITCH
Sensing and Control
Honeywell Inc.
11 West Spring Street
Freeport, Illinois 61032

