



# LUT3-950

LUT3

LUMINESCENCE SENSORS

**SICK**  
Sensor Intelligence.



## Ordering information

Type	Part no.
LUT3-950	1019287

Other models and accessories → [www.sick.com/LUT3](http://www.sick.com/LUT3)



## Detailed technical data

### Features

<b>Dimensions (W x H x D)</b>	30.4 mm x 53 mm x 80 mm
<b>Sensing distance</b>	50 mm <sup>1)</sup>
<b>Housing design (light emission)</b>	Rectangular
<b>Light source</b>	LED, Ultraviolet light <sup>2)</sup>
<b>Wave length</b>	375 nm
<b>Light spot size</b>	5 mm x 15 mm
<b>Receiving filters</b>	KV 418 (standard)
<b>Receiving range</b>	450 nm ... 750 nm
<b>Adjustment</b>	Potentiometer
<b>Output function</b>	Light switching

<sup>1)</sup> From front edge of lens.

<sup>2)</sup> Average service life: 100,000 h at T<sub>J</sub> = +25 °C.

### Mechanics/electronics

<b>Supply voltage</b>	12 V DC ... 30 V DC <sup>1)</sup>
<b>Ripple</b>	< 2 V <sub>pp</sub> <sup>2)</sup>
<b>Power consumption</b>	< 60 mA <sup>3)</sup>
<b>Switching frequency</b>	1.5 kHz <sup>4)</sup>
<b>Response time</b>	350 μs <sup>5)</sup>
<b>Switching output</b>	PNP, NPN
<b>Switching output (voltage)</b>	PNP: HIGH = V <sub>S-</sub> ≤ 3 V / LOW = approx. 0 V

<sup>1)</sup> Limit values when operated in short-circuit protected network: max. 8 A.

<sup>2)</sup> May not exceed or fall below U<sub>V</sub> tolerances.

<sup>3)</sup> Without load.

<sup>4)</sup> With light/dark ratio 1:1.

<sup>5)</sup> Signal transit time with resistive load.

<sup>6)</sup> Reference voltage DC 50 V.

	NPN: HIGH = approx. $V_S$ / LOW $\leq$ 2 V
<b>Switching output</b>	Light switching
<b>Output current <math>I_{max}</math></b>	100 mA
<b>Connection type</b>	Male connector M12, 5-pin
<b>Protection class</b>	II <sup>6)</sup>
<b>Circuit protection</b>	$U_V$ connections, reverse polarity protected Output Q short-circuit protected Interference pulse suppression
<b>Enclosure rating</b>	IP67
<b>Weight</b>	400 g
<b>Housing material</b>	Zinc diecast

1) Limit values when operated in short-circuit protected network: max. 8 A.

2) May not exceed or fall below  $U_V$  tolerances.

3) Without load.

4) With light/dark ratio 1:1.

5) Signal transit time with resistive load.

6) Reference voltage DC 50 V.

## Ambient data

<b>Ambient operating temperature</b>	-10 °C ... +55 °C
<b>Ambient storage temperature</b>	-25 °C ... +75 °C
<b>Shock load</b>	According to IEC 60068

## Classifications

<b>ECl@ss 5.0</b>	27270908
<b>ECl@ss 5.1.4</b>	27270908
<b>ECl@ss 6.0</b>	27270908
<b>ECl@ss 6.2</b>	27270908
<b>ECl@ss 7.0</b>	27270908
<b>ECl@ss 8.0</b>	27270908
<b>ECl@ss 8.1</b>	27270908
<b>ECl@ss 9.0</b>	27270908
<b>ETIM 5.0</b>	EC001822
<b>ETIM 6.0</b>	EC001822
<b>UNSPSC 16.0901</b>	39121528

**Dimensional drawing** (Dimensions in mm (inch))

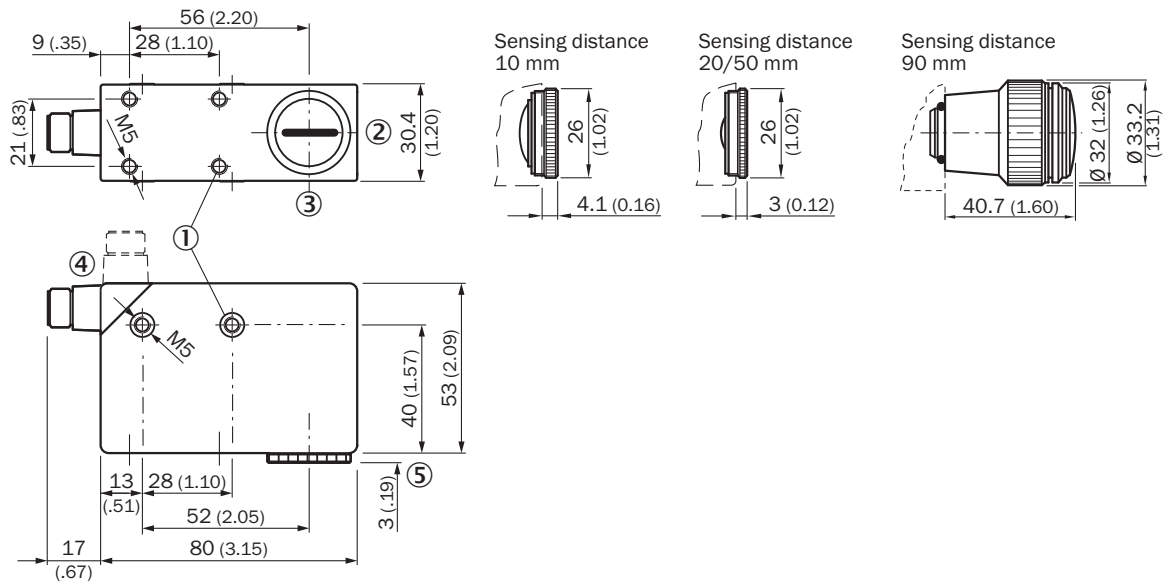

- ① M5 threaded mounting hole, 5.5 mm deep
- ② Light spot direction
- ③ Center of optical axis
- ④ Connector M12 (rotatable up to 90°)
- ⑤ See dimensional drawings of lenses

**Adjustments**

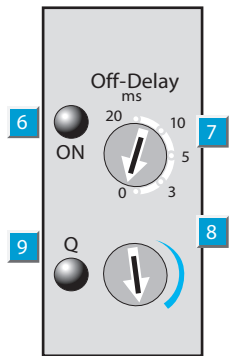

- ⑥ Operating indicator
- ⑦ Time delay selector switch
- ⑧ Sensitivity control
- ⑨ Output indicator

**Connection type**

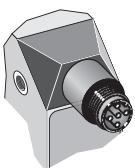

## Connection diagram

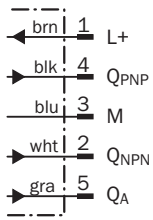



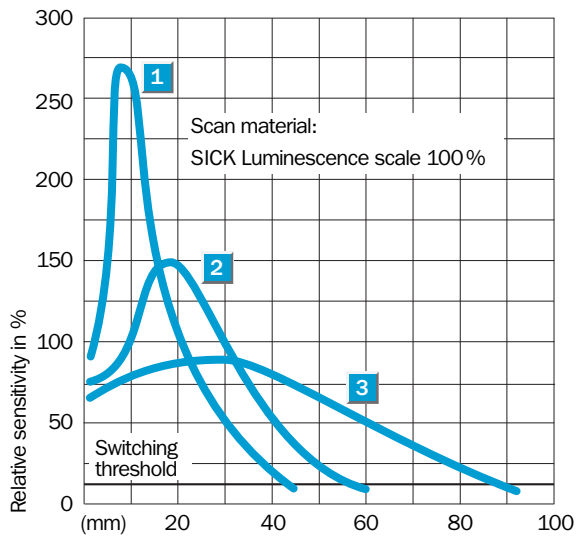



## Characteristic curve



## Recommended accessories

Other models and accessories → [www.sick.com/LUT3](http://www.sick.com/LUT3)

	Brief description	Type	Part no.
Universal bar clamp systems			
	Plate G for universal clamp bracket, steel, zinc coated, Universal clamp (2022726), mounting hardware	BEF-KHS-G01	2022464
	Plate K for universal clamp bracket, steel, zinc coated, Universal clamp (2022726), mounting hardware	BEF-KHS-K01	2022718
	Universal clamp bracket for rod mounting, steel, zinc coated, without mounting hardware	BEF-KHS-KH1	2022726
	Mounting bar, straight, 200 mm, steel, steel, zinc coated, without mounting hardware	BEF-MS12G-A	4056054
	Mounting bar, straight, 300 mm, steel, steel, zinc coated, without mounting hardware	BEF-MS12G-B	4056055

	Brief description	Type	Part no.
	Mounting bar, L-shaped, 150 mm x 150 mm, steel, steel, zinc coated, without mounting hardware	BEF-MS12L-A	4056052
	Mounting bar, L-shaped, 250 x 250 mm, steel, steel, zinc coated, without mounting hardware	BEF-MS12L-B	4056053
Reference materials			
	Crayon, red fluorescence	LUM-FT	1004460
	Writing chalk, red fluorescence	LUM-KLK	1002959

## SICK AT A GLANCE

SICK is one of the leading manufacturers of intelligent sensors and sensor solutions for industrial applications. A unique range of products and services creates the perfect basis for controlling processes securely and efficiently, protecting individuals from accidents and preventing damage to the environment.

We have extensive experience in a wide range of industries and understand their processes and requirements. With intelligent sensors, we can deliver exactly what our customers need. In application centers in Europe, Asia and North America, system solutions are tested and optimized in accordance with customer specifications. All this makes us a reliable supplier and development partner.

Comprehensive services complete our offering: SICK LifeTime Services provide support throughout the machine life cycle and ensure safety and productivity.

For us, that is “Sensor Intelligence.”

## WORLDWIDE PRESENCE:

Contacts and other locations –[www.sick.com](http://www.sick.com)