

# PSD01-1501

M4000 Standard A/P

**MULTIPLE LIGHT BEAM SAFETY DEVICES**

**SICK**  
Sensor Intelligence.

### Ordering information

Number of beams	Beam separation	System part	Type	Part no.
2	500 mm	Deflector unit	PSD01-1501	1027906

Other models and accessories → [www.sick.com/M4000\\_Standard\\_A\\_P](http://www.sick.com/M4000_Standard_A_P)



### Detailed technical data

#### Features

<b>Number of beams</b>	2
<b>Beam separation</b>	500 mm

#### Mechanical data

<b>Dimensions</b>	See dimensional drawing
-------------------	-------------------------

#### Classifications

<b>ECl@ss 5.0</b>	27272703
<b>ECl@ss 5.1.4</b>	27272703
<b>ECl@ss 6.0</b>	27272703
<b>ECl@ss 6.2</b>	27272703
<b>ECl@ss 7.0</b>	27272703
<b>ECl@ss 8.0</b>	27272703
<b>ECl@ss 8.1</b>	27272703
<b>ECl@ss 9.0</b>	27272703
<b>ETIM 5.0</b>	EC001832
<b>ETIM 6.0</b>	EC001832
<b>UNSPSC 16.0901</b>	46171620

**Dimensional drawing** (Dimensions in mm (inch))

Passive unit

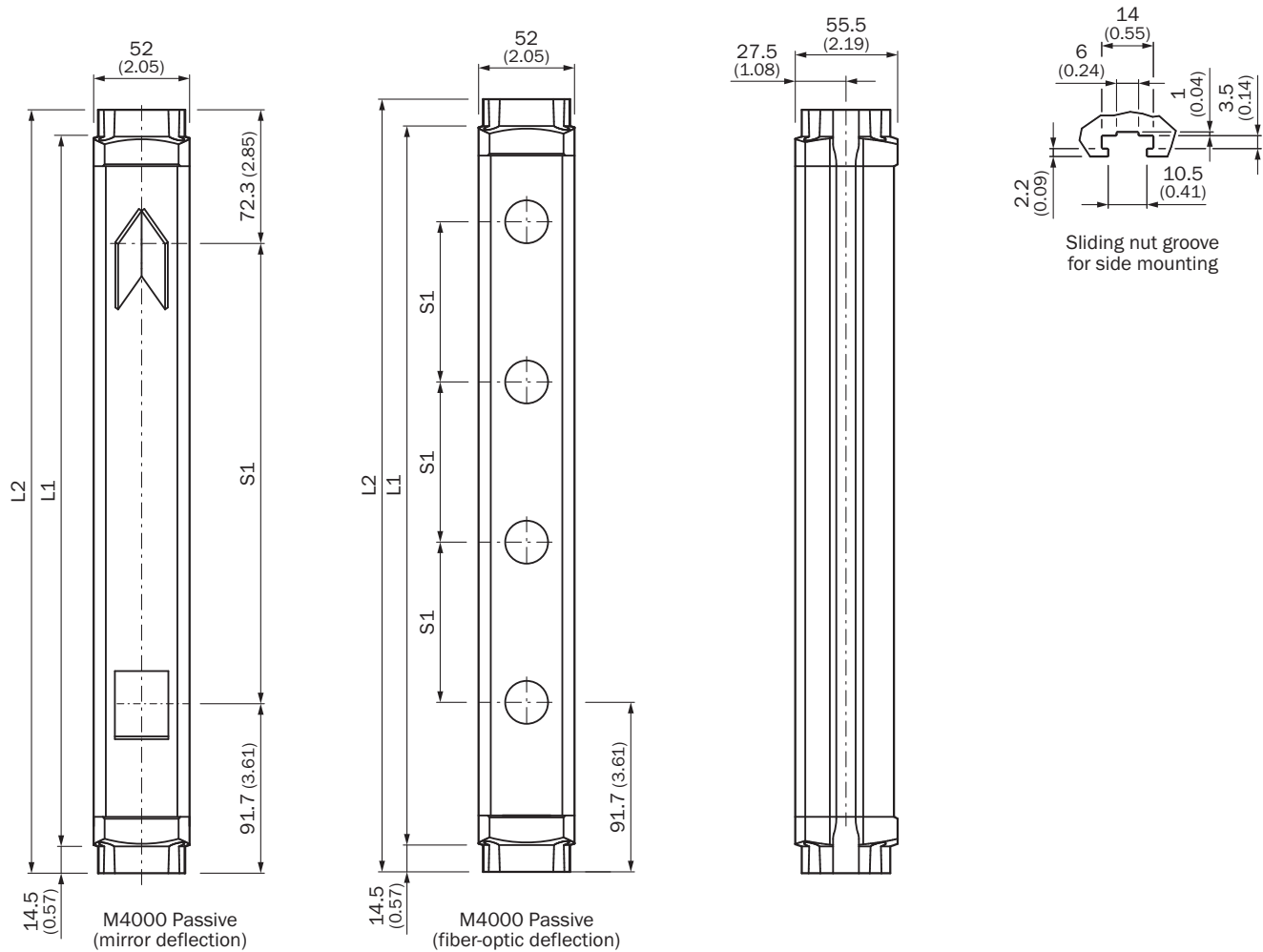







Deflector unit

Number of beams	Beam separation S1	L1	L2
2	500 (19.69)	643 (25.31)	672 (26.46)
4	300 (11.81)	1,043 (41.06)	1,072 (42.20)

**Recommended accessories**

Other models and accessories → [www.sick.com/M4000\\_Standard\\_A\\_P](http://www.sick.com/M4000_Standard_A_P)

	Brief description	Type	Part no.
<b>Mounting brackets and plates</b>			
	4 pieces, Mounting kit 1, mounting bracket, rigid, L-shaped, including fixing screws and washers	BEF-3WNBAST4	7021352

	Brief description	Type	Part no.
Terminal and alignment brackets			
	4 pieces, Mounting kit 6, side bracket, rotatable, Zinc diecast	BEF-1SHABAZN4	2019506
	4 pieces, Mounting kit 12, rotatable, swivel mount	BEF-2SMGEAKU4	2030510
Alignment aids			
	Laser alignment aid for various sensors, laser class 2 (IEC 60825). Do not look into the beam!	AR60	1015741
	Adapter AR60 for M4000 and M4000 Curtain	AR60 adapter, M4000	4040006
Optics cloths			
	Cloth for cleaning optical surfaces	Lens cloth	4003353
Cleaning agent			
	Plastic cleaner and care product, anti-static, 0.5 liter	Plastic cleaner	5600006

## SICK AT A GLANCE

SICK is one of the leading manufacturers of intelligent sensors and sensor solutions for industrial applications. A unique range of products and services creates the perfect basis for controlling processes securely and efficiently, protecting individuals from accidents and preventing damage to the environment.

We have extensive experience in a wide range of industries and understand their processes and requirements. With intelligent sensors, we can deliver exactly what our customers need. In application centers in Europe, Asia and North America, system solutions are tested and optimized in accordance with customer specifications. All this makes us a reliable supplier and development partner.

Comprehensive services complete our offering: SICK LifeTime Services provide support throughout the machine life cycle and ensure safety and productivity.

For us, that is “Sensor Intelligence.”

## WORLDWIDE PRESENCE:

Contacts and other locations –[www.sick.com](http://www.sick.com)