



## PNOZ mo4p

**PILZ**  
THE SPIRIT OF SAFETY

- ▶ Configurable, safe small controllers PNOZmulti Classic

This document is the original document.

All rights to this documentation are reserved by Pilz GmbH & Co. KG. Copies may be made for the user's internal purposes. Suggestions and comments for improving this documentation will be gratefully received.

Source code from third-party manufacturers or open source software has been used for some components. The relevant licence information is available on the Internet on the Pilz homepage.

Pilz®, PIT®, PMI®, PNOZ®, Primo®, PSEN®, PSS®, PVIS®, SafetyBUS p®, SafetyEYE®, SafetyNET p®, the spirit of safety® are registered and protected trademarks of Pilz GmbH & Co. KG in some countries.



SD means Secure Digital

<b>1</b>	<b>Introduction</b>	<b>5</b>
1.1	Validity of documentation	5
1.2	Using the documentation	5
1.3	Definition of symbols	5
<b>2</b>	<b>Overview</b>	<b>7</b>
2.1	Scope	7
2.2	Unit features	7
2.3	Front view	8
<b>3</b>	<b>Safety</b>	<b>9</b>
3.1	Intended use	9
3.2	System requirements	9
3.3	Safety regulations	10
3.3.1	Safety assessment	10
3.3.2	Use of qualified personnel	10
3.3.3	Warranty and liability	10
3.3.4	Disposal	10
3.3.5	For your safety	10
3.4	Safety	11
3.4.1	Intended use	11
3.4.2	System requirements	11
3.4.3	Safety regulations	12
3.4.3.1	Safety assessment	12
3.4.3.2	Use of qualified personnel	12
3.4.3.3	Warranty and liability	12
3.4.3.4	Disposal	12
3.4.3.5	For your safety	12
<b>4</b>	<b>Function description</b>	<b>14</b>
4.1	Integrated protection mechanisms	14
4.2	Functions	14
4.3	System reaction time	14
4.4	Block diagram	14
<b>5</b>	<b>Installation</b>	<b>15</b>
5.1	General installation guidelines	15
5.2	Dimensions in mm	15
5.3	Connecting the base unit and expansion modules	16
<b>6</b>	<b>Commissioning</b>	<b>17</b>
6.1	General wiring guidelines	17
6.2	Connection	17
6.3	Connection example	18
6.4	Download modified project to the PNOZmulti system	18
<b>7</b>	<b>Operation</b>	<b>19</b>
7.1	LED indicators	19

7.2	Function test of the relay outputs.....	19
<b>8</b>	<b>Technical details</b> .....	<b>20</b>
8.1	Safety characteristic data .....	23
<b>9</b>	<b>Supplementary data</b> .....	<b>25</b>
9.1	Service life graph for the relay contacts.....	25
<b>10</b>	<b>Order reference</b> .....	<b>27</b>
10.1	Product .....	27
10.2	Accessories .....	27

# 1 Introduction

## 1.1 Validity of documentation

This documentation is valid for the product PNOZ mo4p. It is valid until new documentation is published.

This operating manual explains the function and operation, describes the installation and provides guidelines on how to connect the product.

## 1.2 Using the documentation

This document is intended for instruction. Only install and commission the product if you have read and understood this document. The document should be retained for future reference.

## 1.3 Definition of symbols

Information that is particularly important is identified as follows:



### **DANGER!**

This warning must be heeded! It warns of a hazardous situation that poses an immediate threat of serious injury and death and indicates preventive measures that can be taken.



### **WARNING!**

This warning must be heeded! It warns of a hazardous situation that could lead to serious injury and death and indicates preventive measures that can be taken.



### **CAUTION!**

This refers to a hazard that can lead to a less serious or minor injury plus material damage, and also provides information on preventive measures that can be taken.



### **NOTICE**

This describes a situation in which the product or devices could be damaged and also provides information on preventive measures that can be taken. It also highlights areas within the text that are of particular importance.



**INFORMATION**

This gives advice on applications and provides information on special features.

## 2 Overview

### 2.1 Scope

- ▶ Expansion module PNOZ mo4p
- ▶ Jumper

### 2.2 Unit features

Application of the product PNOZ mo4p:

Expansion module for connection to a base unit from the configurable control system PNOZmulti

The product has the following features:

- ▶ Positive-guided relay outputs:
  - 4 safety outputs
  - Depending on the application, up to PL e of EN ISO 13849-1 and up to SIL CL 3 of EN IEC 62061
- ▶ Can be configured in the PNOZmulti Configurator
- ▶ Status indicators
- ▶ Max. 6 PNOZ mo4p units can be connected to the base unit
- ▶ Plug-in connection terminals:
  - Either spring-loaded terminal or screw terminal available as an accessory (see Order references for accessories).
- ▶ Coated version:
  - Increased environmental requirements (see [Technical details](#) [ 20])

## 2.3 Front view

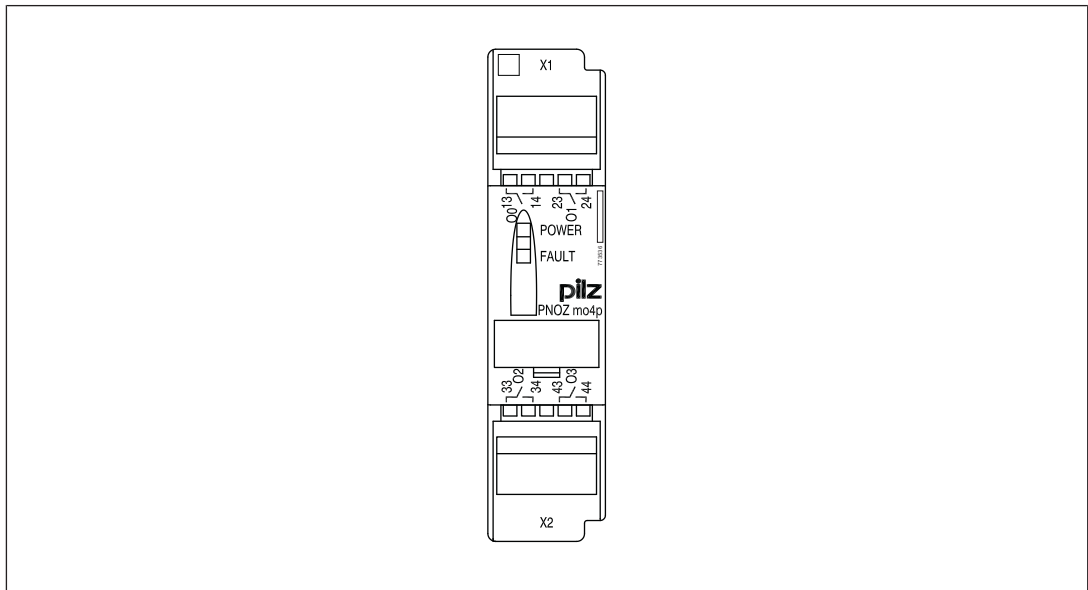

Legend:

- ▶ O0 – O3  
Relay outputs

## 3 Safety

### 3.1 Intended use

The expansion module may only be connected to a base unit from the PNOZmulti system (please refer to the document "PNOZmulti System Expansion" for details of the base units that can be connected).

The configurable small control systems PNOZmulti are used for the safety-related interruption of safety circuits and are designed for use in:

- ▶ E-STOP equipment
- ▶ Safety circuits in accordance with VDE 0113 Part 1 and EN 60204-1

The module can be used in furnaces. If the module's relay outputs shut down the entire fuel supply and the furnace is used in continuous operation, appropriate external measures must be used to establish diversity of the shutdown elements (requirement of EN 50156-1). For example, an appropriate measure may be an additional, monitored switching element (contactor or relay), which is controlled by a safe semiconductor output and is switched in series with both relay outputs.

Alternatively the expansion module PNOZ mo5p can be used.

The coated version of the product PNOZ mo4p is suitable for use where there are increased environmental requirements (see [Technical details](#)  20).

The following is deemed improper use in particular

- ▶ Any component, technical or electrical modification to the product,
- ▶ Use of the product outside the areas described in this manual,
- ▶ Use of the product outside the technical details (see [Technical details](#)  20).



#### NOTICE

##### EMC-compliant electrical installation

The product is designed for use in an industrial environment. The product may cause interference if installed in other environments. If installed in other environments, measures should be taken to comply with the applicable standards and directives for the respective installation site with regard to interference.

### 3.2 System requirements

Please refer to the "Product Modifications PNOZmulti" document in the "Version overview" section for details of which versions of the base unit and PNOZmulti Configurator can be used for this product.

## 3.3 Safety regulations

### 3.3.1 Safety assessment

Before using a device it is necessary to perform a safety assessment in accordance with the Machinery Directive.

Functional safety is guaranteed for the product as a single component. However, this does not guarantee the functional safety of the overall plant/machine. In order to achieve the required safety level for the overall plant/machine, define the safety requirements for the plant/machine and then define how these must be implemented from a technical and organisational standpoint.

### 3.3.2 Use of qualified personnel

The products may only be assembled, installed, programmed, commissioned, operated, maintained and decommissioned by competent persons.

A competent person is someone who, because of their training, experience and current professional activity, has the specialist knowledge required to test, assess and operate the work equipment, devices, systems, plant and machinery in accordance with the general standards and guidelines for safety technology.

It is the company's responsibility only to employ personnel who

- ▶ Are familiar with the basic regulations concerning health and safety / accident prevention,
- ▶ Have read and understood the information provided in this description under "Safety",
- ▶ And have a good knowledge of the generic and specialist standards applicable to the specific application.

### 3.3.3 Warranty and liability

All claims to warranty and liability will be rendered invalid if

- ▶ The product was used contrary to the purpose for which it is intended,
- ▶ Damage can be attributed to not having followed the guidelines in the manual,
- ▶ Operating personnel are not suitably qualified,
- ▶ Any type of modification has been made (e.g. exchanging components on the PCB boards, soldering work etc.).

### 3.3.4 Disposal

- ▶ In safety-related applications, please comply with the mission time  $T_M$  in the safety-related characteristic data.
- ▶ When decommissioning, please comply with local regulations regarding the disposal of electronic devices (e.g. Electrical and Electronic Equipment Act).

### 3.3.5 For your safety

The unit meets all the necessary conditions for safe operation. However, you should always ensure that the following safety requirements are met:

- ▶ This operating manual only describes the basic functions of the unit. The expanded functions are described in the PNOZmulti Configurator's online help. Only use these functions once you have read and understood the documentations.
- ▶ Do not open the housing or make any unauthorised modifications.
- ▶ Please make sure you shut down the supply voltage when performing maintenance work (e.g. exchanging contactors).

## 3.4 Safety

### 3.4.1 Intended use

The expansion module may only be connected to a base unit from the configurable system PNOZmulti (please refer to the document "PNOZmulti System Expansion" for details of the base units that can be connected).

The configurable system PNOZmulti is used for the safety-related interruption of safety circuits and is designed for use in:

- ▶ Emergency stop equipment
- ▶ Safety circuits in accordance with VDE 0113 Part 1 and EN 60204-1
- ▶ The module PNOZ mo4p may be used as a safety component in accordance with the Lifts Directive 95/16/EC and in accordance with the requirements of EN 81-20, EN 81-50 and EN 115-1.
- ▶ The programmable safety system should be installed in a protected environment that meets at least the requirements of pollution degree 2.  
Example: Protected inside space or control cabinet with protection class IP54 and corresponding air conditioning.

The following is deemed improper use in particular

- ▶ Any component, technical or electrical modification to the product,
- ▶ Use of the product outside the areas described in this manual,
- ▶ Use of the product outside the technical details (see [Technical details](#)  20).



#### **NOTICE** **EMC-compliant electrical installation**

The product is designed for use in an industrial environment. The product may cause interference if installed in other environments. If installed in other environments, measures should be taken to comply with the applicable standards and directives for the respective installation site with regard to interference.

### 3.4.2 System requirements

Please refer to the "Product Modifications PNOZmulti" document in the "Version overview" section for details of which versions of the base unit and PNOZmulti Configurator can be used for this product.

### 3.4.3 Safety regulations

#### 3.4.3.1 Safety assessment

Before using a device it is necessary to perform a safety assessment in accordance with the Machinery Directive.

Functional safety is guaranteed for the product as a single component. However, this does not guarantee the functional safety of the overall plant/machine. In order to achieve the required safety level for the overall plant/machine, define the safety requirements for the plant/machine and then define how these must be implemented from a technical and organisational standpoint.

#### 3.4.3.2 Use of qualified personnel

The products may only be assembled, installed, programmed, commissioned, operated, maintained and decommissioned by competent persons.

A competent person is someone who, because of their training, experience and current professional activity, has the specialist knowledge required to test, assess and operate the work equipment, devices, systems, plant and machinery in accordance with the general standards and guidelines for safety technology.

It is the company's responsibility only to employ personnel who

- ▶ Are familiar with the basic regulations concerning health and safety / accident prevention,
- ▶ Have read and understood the information provided in this description under "Safety",
- ▶ And have a good knowledge of the generic and specialist standards applicable to the specific application.

#### 3.4.3.3 Warranty and liability

All claims to warranty and liability will be rendered invalid if

- ▶ The product was used contrary to the purpose for which it is intended,
- ▶ Damage can be attributed to not having followed the guidelines in the manual,
- ▶ Operating personnel are not suitably qualified,
- ▶ Any type of modification has been made (e.g. exchanging components on the PCB boards, soldering work etc.).

#### 3.4.3.4 Disposal

- ▶ In safety-related applications, please comply with the mission time  $T_M$  in the safety-related characteristic data.
- ▶ When decommissioning, please comply with local regulations regarding the disposal of electronic devices (e.g. Electrical and Electronic Equipment Act).

#### 3.4.3.5 For your safety

The unit meets all the necessary conditions for safe operation. However, you should always ensure that the following safety requirements are met:

- ▶ This operating manual only describes the basic functions of the unit. The expanded functions are described in the PNOZmulti Configurator's online help. Only use these functions once you have read and understood the documentations.

- ▶ Do not open the housing or make any unauthorised modifications.
- ▶ Please make sure you shut down the supply voltage when performing maintenance work (e.g. exchanging contactors).

## 4 Function description

### 4.1 Integrated protection mechanisms

The relay meets the following safety requirements:

- ▶ The circuit is redundant with built-in self-monitoring.
- ▶ The safety device remains effective in the case of a component failure.
- ▶ The relay contacts meet the requirements for protective separation through increased insulation compared with all other circuits in the safety system.

### 4.2 Functions

The expansion module provides additional relay outputs.

The function of the outputs on the safety system depends on the safety circuit created using the PNOZmulti Configurator. A chip card is used to download the safety circuit to the base unit. The base unit has 2 microcontrollers that monitor each other. They evaluate the input circuits on the base unit and expansion modules and switch the outputs on the base unit and expansion modules accordingly.

The online help on the PNOZmulti Configurator contains descriptions of the operating modes and all the functions of the PNOZmulti safety system, plus connection examples.

### 4.3 System reaction time

Calculation of the maximum reaction time between an input switching off and a linked output in the system switching off is described in the document "PNOZmulti System Expansion".

### 4.4 Block diagram

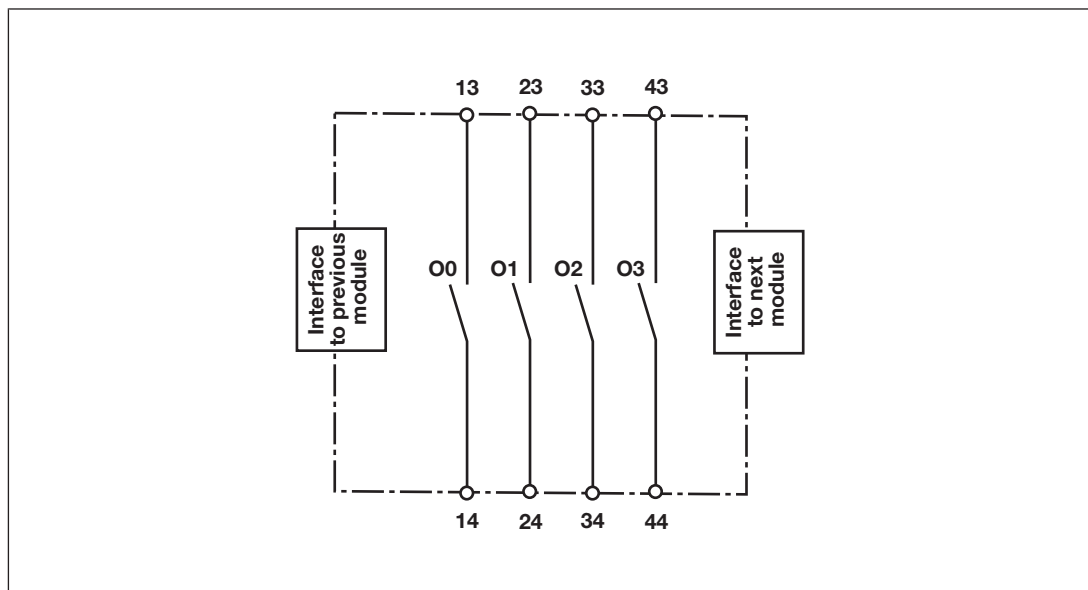

## 5 Installation

### 5.1 General installation guidelines

- ▶ The control system should be installed in a control cabinet with a protection type of at least IP54. Fit the control system to a horizontal mounting rail. The venting slots must face upward and downward. Other mounting positions could destroy the control system.
- ▶ Use the locking elements on the rear of the unit to attach it to a mounting rail. Connect the control system to the mounting rail in an upright position, so that the earthing springs on the control system are pressed on to the mounting rail.
- ▶ The ambient temperature of the devices in the control cabinet must not exceed the figure stated in the technical details. Air conditioning may otherwise be required.
- ▶ To comply with EMC requirements, the mounting rail must have a low impedance connection to the control cabinet housing.



#### NOTICE

Damage due to electrostatic discharge!

Electrostatic discharge can damage components. Ensure against discharge before touching the product, e.g. by touching an earthed, conductive surface or by wearing an earthed armband.

### 5.2 Dimensions in mm

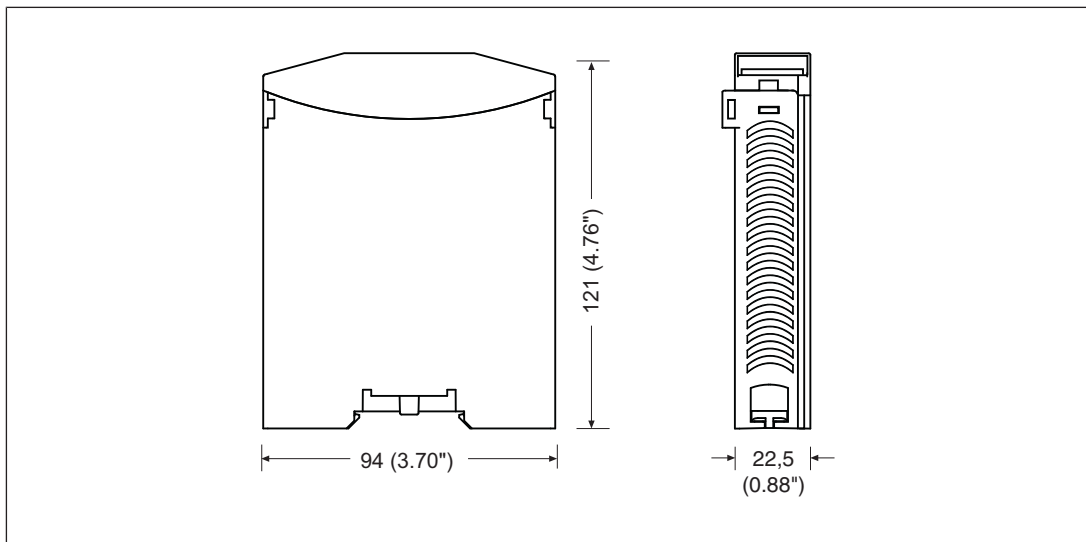

### 5.3 Connecting the base unit and expansion modules

Connect the base unit and the expansion modules as described in the operating manuals for the base modules.

- ▶ The terminator must be fitted to the last expansion module
- ▶ Install the expansion module in the position configured in the PNOZmulti Configurator.

The position of the expansion modules is defined in the PNOZmulti Configurator. The expansion modules are connected to the left or right of the base unit, depending on the type.

Please refer to the document "PNOZmulti System Expansion" for details of the number of modules that can be connected to the base unit and the module types.

## 6 Commissioning

### 6.1 General wiring guidelines

The wiring is defined in the circuit diagram of the PNOZmulti Configurator.

Please note:

- ▶ Information given in the [Technical details \[20\]](#) must be followed.
- ▶ The position of the expansion module is specified in the Hardware configuration of the PNOZmulti Configurator.
- ▶ Use copper wiring with a temperature stability of 75 °C.

### 6.2 Connection

<p>Redundant</p>		
<p>single</p>		
<p>Feedback loop Contacts from external contactors</p>		

### 6.3 Connection example

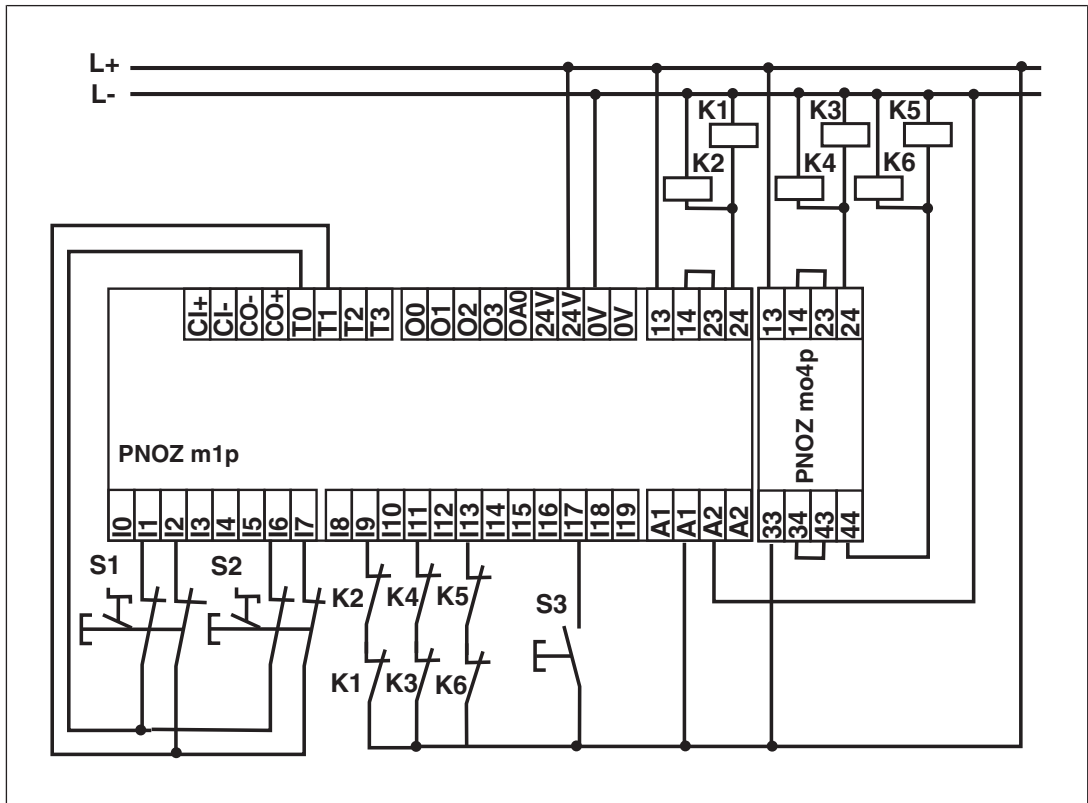

### 6.4 Download modified project to the PNOZmulti system

As soon as an additional expansion module has been connected to the system, the project must be amended in the PNOZmulti Configurator and downloaded back into the base unit. Proceed as described in the operating manual for the base unit.



**NOTICE**

For the commissioning and after every user program change, you must check whether the safety devices are functioning correctly.



## 7 Operation





When the supply voltage is switched on, the PNOZmulti copies the configuration from the chip card.

The PNOZmulti system is ready for operation when the "POWER" and "RUN" LEDs on the base unit are lit continuously.

### 7.1 LED indicators

#### Legend

-  LED on
-  LED flashes
-  LED off

Basis								PNOZ mo4p		Error
Input Ix	Run	Diag	Fault	IFAULT	OFAULT	CI	CO	Fault	IN/OUT	
										External error on the output, e.g. defective feedback loop
										Internal error on the expansion module

### 7.2 Function test of the relay outputs

When the relay outputs are switched on, the mechanical contact on the relay cannot be tested automatically. Depending on the operational environment, measures to detect the non-opening of switching elements may be required under some circumstances.

When the product is used in accordance with the European Machinery Directive, a check must be carried out to ensure that the safety contacts on the relay outputs open correctly. Start the device again or open the safety contacts (switch off output), so that the internal diagnostics can check the correct opening of the safety contacts

- ▶ for SIL CL 3/PL e at least 1x per month
- ▶ for SIL CL 2/PL d at least 1x per year

## 8 Technical details

<b>General</b>	<b>773536</b>	<b>773537</b>
Certifications	BG, CCC, CE, EAC (Eurasian), KOSHA, TÜV, cULus Listed	BG, CCC, CE, EAC (Eurasian), KOSHA, TÜV, cULus Listed
<b>Electrical data</b>	<b>773536</b>	<b>773537</b>
Supply voltage		
for	<b>Module supply</b>	<b>Module supply</b>
internal	<b>Via base unit</b>	<b>Via base unit</b>
Voltage	<b>5,0 V</b>	<b>5,0 V</b>
Kind	<b>DC</b>	<b>DC</b>
Voltage tolerance	<b>-2 %/+2 %</b>	<b>-2 %/+2 %</b>
Power consumption	<b>2,5 W</b>	<b>2,5 W</b>
Status indicator	<b>LED</b>	<b>LED</b>
<b>Relay outputs</b>	<b>773536</b>	<b>773537</b>
Utilisation category		
In accordance with the standard	<b>EN 60947-4-1</b>	<b>EN 60947-4-1</b>
Utilisation category of safety contacts		
AC1 at	<b>240 V</b>	<b>240 V</b>
Min. current	<b>10,00 mA</b>	<b>10,00 mA</b>
Max. current	<b>6,0 A</b>	<b>6,0 A</b>
Max. power	<b>1440 VA</b>	<b>1440 VA</b>
DC1 at	<b>24 V</b>	<b>24 V</b>
Min. current	<b>10,00 mA</b>	<b>10,00 mA</b>
Max. current	<b>6,0 A</b>	<b>6,0 A</b>
Max. power	<b>144 W</b>	<b>144 W</b>
Safety contacts, AC1 at	–	<b>240 V</b>
Max. current	–	<b>2 A</b>
Max. power	–	<b>480 W</b>
Safety contacts, DC 1 at	–	<b>24 V</b>
Max. current	–	<b>2 A</b>
Max. power	–	<b>48 W</b>
Utilisation category		
In accordance with the standard	<b>EN 60947-5-1</b>	<b>EN 60947-5-1</b>

<b>Relay outputs</b>	<b>773536</b>	<b>773537</b>
Utilisation category of safety contacts		
AC15 at	<b>230 V</b>	<b>230 V</b>
Max. current	<b>3,0 A</b>	<b>3,0 A</b>
Max. power	<b>690 W</b>	<b>690 W</b>
DC13 (6 cycles/min) at	<b>24 V</b>	<b>24 V</b>
Max. current	<b>3,0 A</b>	<b>3,0 A</b>
Max. power	<b>72 W</b>	<b>72 W</b>
AC15 at	–	<b>230 V</b>
Max. current	–	<b>2 A</b>
Max. power	–	<b>460 W</b>
DC13 (6 cycles/min) at	–	<b>24 V</b>
Max. current	–	<b>2 A</b>
Max. power	–	<b>48 W</b>
Max. permitted total current of relay outputs at an ambient temperature of > 50 °C	<b>12 A</b>	–
Airgap creepage between		
Relay contacts	<b>3 mm</b>	<b>3 mm</b>
Relay contacts and other circuits	<b>5,5 mm</b>	<b>5,5 mm</b>
External contact fuse protection, safety contacts		
In accordance with the standard	<b>EN 60947-5-1</b>	<b>EN 60947-5-1</b>
Blow-out fuse, quick	<b>6 A</b>	<b>6 A</b>
Blow-out fuse, slow	<b>6,00 A</b>	<b>6,00 A</b>
Circuit breaker 24V AC/DC, characteristic B/C	<b>6 A</b>	<b>6 A</b>
Switch-off delay	<b>50 ms</b>	<b>50 ms</b>
Conventional thermal current	<b>12,0 A</b>	<b>12,0 A</b>
<b>Times</b>	<b>773536</b>	<b>773537</b>
Switch-on delay	<b>5,00 s</b>	<b>5,00 s</b>
Supply interruption before de-energisation	<b>20 ms</b>	<b>20 ms</b>
<b>Environmental data</b>	<b>773536</b>	<b>773537</b>
Ambient temperature		
In accordance with the standard	<b>EN 60068-2-14</b>	<b>EN 60068-2-14</b>
Temperature range	<b>0 - 60 °C</b>	<b>-25 - 60 °C</b>
Forced convection in control cabinet off	<b>55 °C</b>	–
Storage temperature		
In accordance with the standard	<b>EN 60068-2-1/-2</b>	<b>EN 60068-2-1/-2</b>
Temperature range	<b>-25 - 70 °C</b>	<b>-25 - 70 °C</b>
Climatic suitability		
In accordance with the standard	<b>EN 60068-2-30, EN 60068-2-78</b>	<b>EN 60068-2-30, EN 60068-2-78</b>
Humidity	<b>93 % r. h. at 40 °C</b>	<b>93 % r. h. at 40 °C</b>

<b>Environmental data</b>	<b>773536</b>	<b>773537</b>
Condensation during operation	<b>Not permitted</b>	<b>Short-term (only with separated extra low voltage)</b>
EMC	<b>EN 61131-2</b>	<b>EN 61131-2</b>
Vibration		
In accordance with the standard	<b>EN 60068-2-6</b>	<b>EN 60068-2-6</b>
Frequency	<b>10,0 - 150,0 Hz</b>	<b>5,0 - 500,0 Hz</b>
Acceleration	<b>1g</b>	<b>1g</b>
Broadband noise		
In accordance with the standard	–	<b>EN 60068-2-64</b>
Frequency	–	<b>5 - 500 Hz</b>
Acceleration	–	<b>1,9grms</b>
Corrosive gas check		
SO <sub>2</sub> : Concentration 10 ppm, duration 10 days, passive	–	<b>DIN V 40046-36</b>
H <sub>2</sub> S: Concentration 1 ppm, duration 10 days, passive	–	<b>DIN V 40046-37</b>
Shock stress		
In accordance with the standard	<b>EN 60068-2-27</b>	<b>EN 60068-2-27</b>
Acceleration	<b>15g</b>	<b>15g</b>
Duration	<b>11 ms</b>	<b>11 ms</b>
Max. operating height above sea level	<b>2000 m</b>	<b>2000 m</b>
Airgap creepage		
In accordance with the standard	<b>EN 61131-2</b>	<b>EN 61131-2</b>
Overvoltage category	<b>III</b>	<b>III</b>
Pollution degree	<b>2</b>	<b>2</b>
Rated insulation voltage	<b>250 V</b>	<b>250 V</b>
Rated impulse withstand voltage	<b>6,00 kV</b>	<b>6,00 kV</b>
Protection type		
In accordance with the standard	<b>EN 60529</b>	<b>EN 60529</b>
Mounting area (e.g. control cabinet)	<b>IP54</b>	<b>IP54</b>
Housing	<b>IP20</b>	<b>IP20</b>
Terminals	<b>IP20</b>	<b>IP20</b>
<b>Mechanical data</b>	<b>773536</b>	<b>773537</b>
Mounting position	<b>horizontally on mounting rail</b>	<b>horizontally on mounting rail</b>
DIN rail		
Top hat rail	<b>35 x 7,5 EN 50022</b>	<b>35 x 7,5 EN 50022</b>
Recess width	<b>27 mm</b>	<b>27 mm</b>
Material		
Bottom	<b>PPO UL 94 V0</b>	<b>PPO UL 94 V0</b>
Front	<b>ABS UL 94 V0</b>	<b>ABS UL 94 V0</b>
Connection type	<b>Spring-loaded terminal, screw terminal</b>	<b>Spring-loaded terminal, screw terminal</b>

Mechanical data	773536	773537
Conductor cross section with screw terminals (relay outputs)		
1 core flexible	0,25 - 2,50 mm <sup>2</sup> , 24 - 12 AWG	0,25 - 2,50 mm <sup>2</sup> , 24 - 12 AWG
2 core with the same cross section, flexible without crimp connectors or with TWIN crimp connectors	0,25 - 1,50 mm <sup>2</sup> , 24 - 16 AWG	0,25 - 1,50 mm <sup>2</sup> , 24 - 16 AWG
Torque setting with screw terminals (relay outputs)		
	0,50 Nm	0,50 Nm
Stripping length with screw terminals (relay outputs)		
	8 mm	8 mm
Conductor cross section with spring-loaded terminals (relay outputs)		
1 core flexible without crimp connector	0,25 - 2,50 mm <sup>2</sup> , 24 - 12 AWG	0,25 - 2,50 mm <sup>2</sup> , 24 - 12 AWG
1 core flexible with crimp connector	0,25 - 1,50 mm <sup>2</sup> , 24 - 16 AWG	0,25 - 1,50 mm <sup>2</sup> , 24 - 16 AWG
Spring-loaded terminals: Terminal points per connection		
	1	1
Stripping length with spring-loaded terminals (relay outputs)		
	10 mm	10 mm
Dimensions		
Height	94,0 mm	94,0 mm
Width	22,5 mm	22,5 mm
Depth	121,0 mm	121,0 mm
Weight		
	204 g	204 g

Where standards are undated, the 2009-01 latest editions shall apply.

## 8.1 Safety characteristic data



### NOTICE

You must comply with the safety characteristic data in order to achieve the required safety level for your plant/machine.

Operating mode	EN ISO 13849-1: 2015	EN ISO 13849-1: 2015	EN 62061 SIL CL	EN 62061 PFH <sub>D</sub> [1/h]	IEC 61511 SIL	IEC 61511 PFD	EN ISO 13849-1: 2015 T <sub>M</sub> [year]
	PL	Category					
1-channel	PL c	Cat. 1	-	2,90E-08	-	2,60E-03	20
2-channel	PL e	Cat. 4	SIL CL 3	3,00E-10	SIL 3	5,20E-07	20

All the units used within a safety function must be considered when calculating the safety characteristic data.



#### INFORMATION

A safety function's SIL/PL values are **not** identical to the SIL/PL values of the units that are used and may be different. We recommend that you use the PAScal software tool to calculate the safety function's SIL/PL values.



#### CAUTION!

It is essential to consider the relay's service life graphs. The relay outputs' safety-related characteristic data is only valid if the values in the service life graphs are met.

The PFH value depends on the switch frequency and the load of the relay output. If the service life graphs are not accessible, the stated PFH value can be used irrespective of the switch frequency and the load, as the PFH value already considers the relay's B10d value as well as the failure rates of the other components.

## 9 Supplementary data

### 9.1 Service life graph for the relay contacts

The service life graphs indicate the number of cycles from which failures due to wear must be expected. The wear is mainly caused by the electrical load; the mechanical load is negligible.

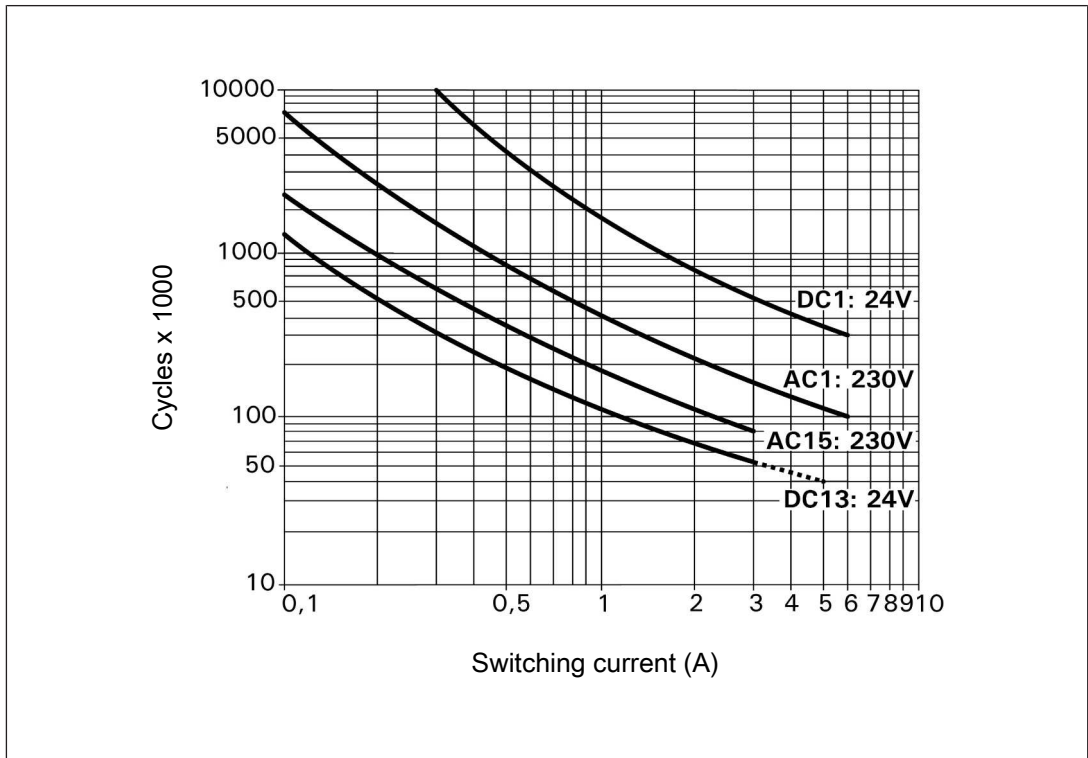

Fig.: Service life graphs at 24 VDC and 230 VAC

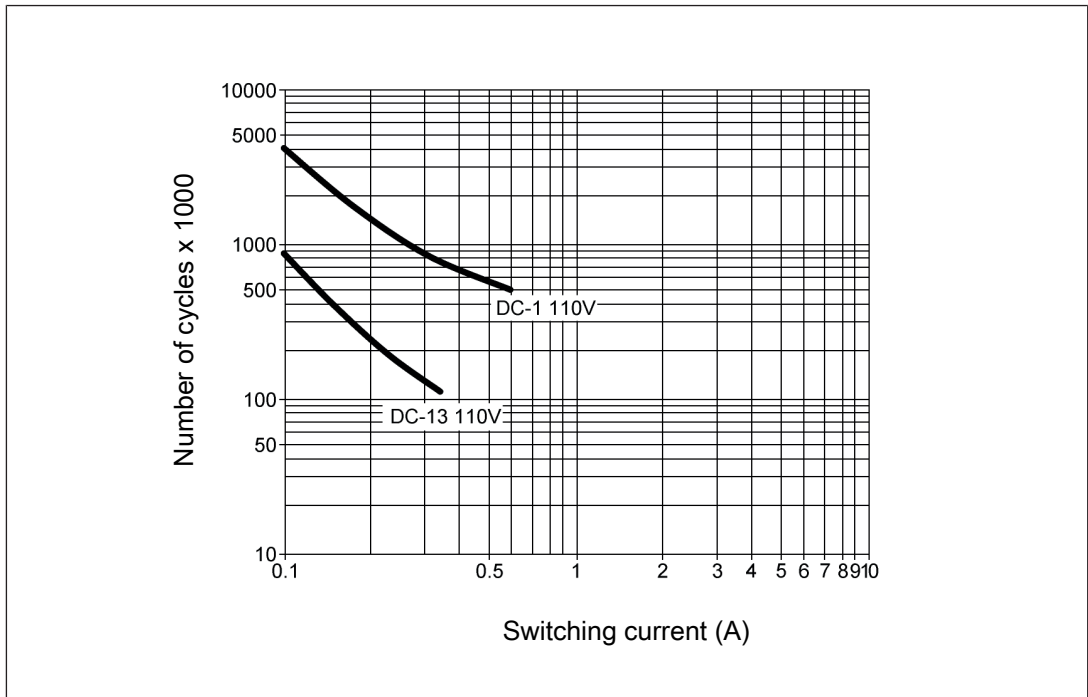

Fig.: Service life graphs at 110 VDC

**Example**

- ▶ Inductive load: 0.2 A
- ▶ Utilisation category: AC15
- ▶ Contact service life: 1 000 000 cycles

Provided the application to be implemented requires fewer than 1 000 000 cycles, the PFH value (see [Technical details \[📖 20\]](#)) can be used in the calculation.

To increase the service life, sufficient spark suppression must be provided on all relay contacts. With capacitive loads, any power surges that occur must be noted. With DC contactors, use flywheel diodes for spark suppression.

We recommend you use semiconductor outputs to switch 24 VDC loads.

## 10 Order reference

### 10.1 Product

Product type	Features	Order No.
PNOZ mo4p	Expansion module, 2 or 4 relay outputs, positive-guided	773 536
PNOZ mo4p coated version	Expansion module, 2 or 4 relay outputs, positive-guided, coated version	773 537

### 10.2 Accessories

#### Connection terminals

Product type	Features	Order No.
Set spring terminals	1 set of spring-loaded terminals	783 536
Set screw terminals	1 set of screw terminals	793 536

#### Terminator, jumper

Product type	Features	Order No.
PNOZmulti bus terminator	Terminator	779 110
PNOZmulti bus terminator coated	Terminator, coated version	779 112
KOP-XE	Jumper	774 639
KOP-XE coated	Jumper, coated version	774 640

# ► Support

Technical support is available from Pilz round the clock.

## Americas

### Brazil

+55 11 97569-2804

### Canada

+1 888-315-PILZ (315-7459)

### Mexico

+52 55 5572 1300

### USA (toll-free)

+1 877-PILZUSA (745-9872)

## Asia

### China

+86 21 60880878-216

### Japan

+81 45 471-2281

### South Korea

+82 31 450 0680

## Australia

+61 3 95600621

## Europe

### Austria

+43 1 7986263-0

### Belgium, Luxembourg

+32 9 3217575

### France

+33 3 88104000

### Germany

+49 711 3409-444

### Ireland

+353 21 4804983

### Italy, Malta

+39 0362 1826711

## Scandinavia

+45 74436332

## Spain

+34 938497433

## Switzerland

+41 62 88979-30

## The Netherlands

+31 347 320477

## Turkey

+90 216 5775552

## United Kingdom

+44 1536 462203

## You can reach our international hotline on:

+49 711 3409-444

support@pilz.com

Pilz develops environmentally-friendly products using ecological materials and energy-saving technologies. Offices and production facilities are ecologically designed, environmentally-aware and energy-saving. So Pilz offers sustainability, plus the security of using energy-efficient products and environmentally-friendly solutions.

*Energy*  
saving by Pilz



Pilz GmbH & Co. KG  
Felix-Wankel-Straße 2  
73760 Ostfildern, Germany  
Tel.: +49 711 3409-0  
Fax: +49 711 3409-133  
info@pilz.com  
www.pilz.com

**PILZ**  
THE SPIRIT OF SAFETY

CMSE®, IndurANET p®, PAS4000®, PASscal®, PASconfig®, Pilz®, PIT®, PLID®, PMCPirotego®, PMCiendo®, PMD®, PMi®, PNOZ®, Pirmo®, PSEN®, PSS®, PVS®, SafetyBUS SafetyEYE®, SafetyNET p®, THE SPIRIT OF SAFETY® are registered and protected trademarks of Pilz GmbH & Co. KG in some countries. We would point out that product features mentioned in the details stated in this document, depending on the status at the time of publication and the scope of the equipment. We accept no responsibility for the validity, accuracy and entirety of the text and graphics presented in this information. Please contact our Technical Support if you have any questions.