



LUT3-852

LUT3

LUMINESCENCE SENSORS

SICK
Sensor Intelligence.



Ordering information

Type	Part no.
LUT3-852	1012871

Other models and accessories → www.sick.com/LUT3



Detailed technical data

Features

Dimensions (W x H x D)	30.4 mm x 53 mm x 80 mm
Sensing distance	50 mm ¹⁾
Housing design (light emission)	Rectangular
Light source	LED, Ultraviolet light ²⁾
Wave length	375 nm
Light spot size	5 mm x 15 mm
Receiving filters	RG 610
Receiving range	610 nm ... 750 nm
Adjustment	Potentiometer
Output function	Light switching

¹⁾ From front edge of lens.

²⁾ Average service life: 100,000 h at T_J = +25 °C.

Mechanics/electronics

Supply voltage	12 V DC ... 30 V DC ¹⁾
Ripple	< 2 V _{pp} ²⁾
Power consumption	< 60 mA ³⁾
Switching frequency	1.5 kHz ⁴⁾
Response time	350 μs ⁵⁾
Switching output	PNP, NPN
Switching output (voltage)	PNP: HIGH = V _{S-} ≤ 3 V / LOW = approx. 0 V

¹⁾ Limit values when operated in short-circuit protected network: max. 8 A.

²⁾ May not exceed or fall below U_V tolerances.

³⁾ Without load.

⁴⁾ With light/dark ratio 1:1.

⁵⁾ Signal transit time with resistive load.

⁶⁾ Reference voltage DC 50 V.

	NPN: HIGH = approx. V_S / LOW \leq 2 V
Switching output	Light switching
Output current I_{max}	100 mA
Connection type	Male connector M12, 5-pin
Protection class	II ⁶⁾
Circuit protection	U_V connections, reverse polarity protected Output Q short-circuit protected Interference pulse suppression
Enclosure rating	IP67
Weight	400 g
Housing material	Zinc diecast

1) Limit values when operated in short-circuit protected network: max. 8 A.

2) May not exceed or fall below U_V tolerances.

3) Without load.

4) With light/dark ratio 1:1.

5) Signal transit time with resistive load.

6) Reference voltage DC 50 V.

Ambient data

Ambient operating temperature	-10 °C ... +55 °C
Ambient storage temperature	-25 °C ... +75 °C
Shock load	According to IEC 60068
UL File No.	NRKH.E181493 & NRKH7.E181493

Classifications

ECl@ss 5.0	27270908
ECl@ss 5.1.4	27270908
ECl@ss 6.0	27270908
ECl@ss 6.2	27270908
ECl@ss 7.0	27270908
ECl@ss 8.0	27270908
ECl@ss 8.1	27270908
ECl@ss 9.0	27270908
ETIM 5.0	EC001822
ETIM 6.0	EC001822
UNSPSC 16.0901	39121528

Dimensional drawing (Dimensions in mm (inch))

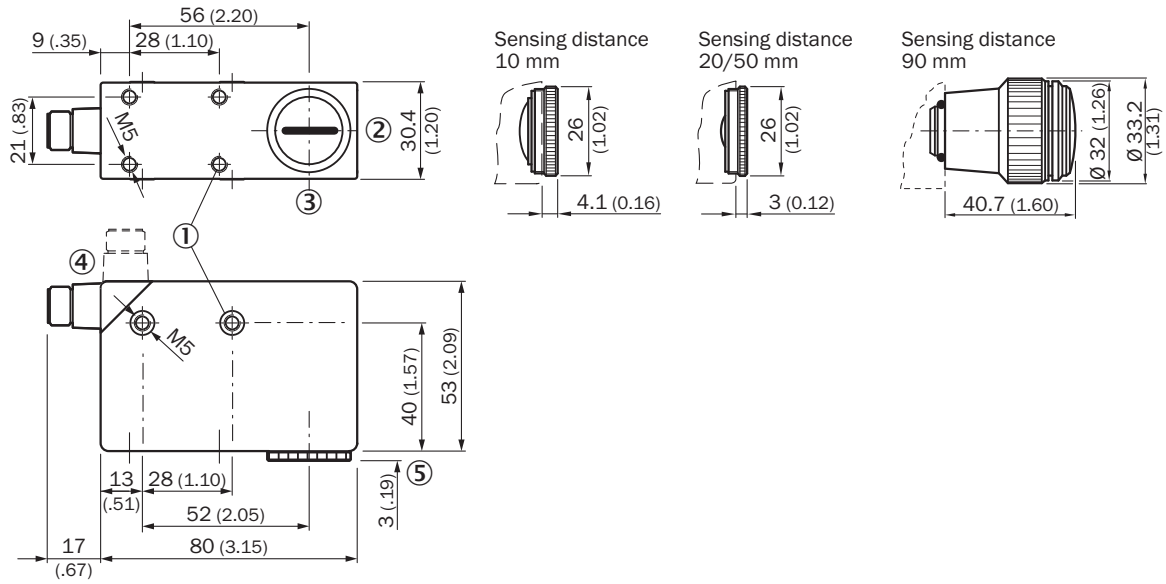

- ① M5 threaded mounting hole, 5.5 mm deep
- ② Light spot direction
- ③ Center of optical axis
- ④ Connector M12 (rotatable up to 90°)
- ⑤ See dimensional drawings of lenses

Adjustments

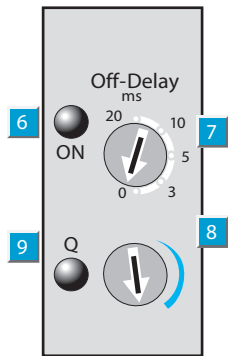

- ⑥ Operating indicator
- ⑦ Time delay selector switch
- ⑧ Sensitivity control
- ⑨ Output indicator

Connection type

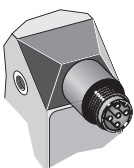

Connection diagram

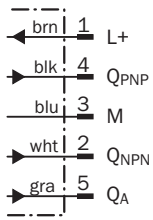



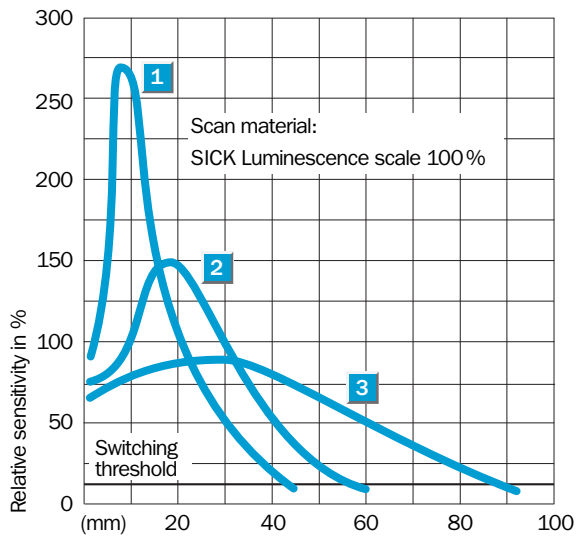



Characteristic curve



Recommended accessories

Other models and accessories → www.sick.com/LUT3

	Brief description	Type	Part no.
Universal bar clamp systems			
	Plate G for universal clamp bracket, steel, zinc coated, Universal clamp (2022726), mounting hardware	BEF-KHS-G01	2022464
	Plate K for universal clamp bracket, steel, zinc coated, Universal clamp (2022726), mounting hardware	BEF-KHS-K01	2022718
	Universal clamp bracket for rod mounting, steel, zinc coated, without mounting hardware	BEF-KHS-KH1	2022726
	Mounting bar, straight, 200 mm, steel, steel, zinc coated, without mounting hardware	BEF-MS12G-A	4056054
	Mounting bar, straight, 300 mm, steel, steel, zinc coated, without mounting hardware	BEF-MS12G-B	4056055

	Brief description	Type	Part no.
	Mounting bar, L-shaped, 150 mm x 150 mm, steel, steel, zinc coated, without mounting hardware	BEF-MS12L-A	4056052
	Mounting bar, L-shaped, 250 x 250 mm, steel, steel, zinc coated, without mounting hardware	BEF-MS12L-B	4056053
Reference materials			
	Crayon, red fluorescence	LUM-FT	1004460
	Writing chalk, red fluorescence	LUM-KLK	1002959

SICK AT A GLANCE

SICK is one of the leading manufacturers of intelligent sensors and sensor solutions for industrial applications. A unique range of products and services creates the perfect basis for controlling processes securely and efficiently, protecting individuals from accidents and preventing damage to the environment.

We have extensive experience in a wide range of industries and understand their processes and requirements. With intelligent sensors, we can deliver exactly what our customers need. In application centers in Europe, Asia and North America, system solutions are tested and optimized in accordance with customer specifications. All this makes us a reliable supplier and development partner.

Comprehensive services complete our offering: SICK LifeTime Services provide support throughout the machine life cycle and ensure safety and productivity.

For us, that is “Sensor Intelligence.”

WORLDWIDE PRESENCE:

Contacts and other locations –www.sick.com