

# Manual Switches

## Pushbutton Switches

PB Series

### FEATURES

- Compact size
- Up to 4-poles
- Sealed versions

### TOUCH FEEDBACK SWITCHES



### ORDER GUIDE

Momentary and alternate action switches.

Button Color	No. of SPDT Circuits		
	2 Mom. Action	2 Alt. Action	4 Mom. Action
Black	2PB11-T2	82PB19-T2	—
	2PB732-T2 (M8805/23-001)	—	4PB714-T2 (M8805/23-003)
Red	2PB12-T2	—	—
	2PB717-T2 (M8805/23-002)	—	—
Green	2PB273-T2	—	—

### SHORT TRAVEL SWITCHES



### ORDER GUIDE

Momentary action switches.

Button	No. of SPDT Circuits	
	2	3
Black	2PB7	3PB7

These switches resemble the touch-feedback design, but have a flexible leaf actuator for lower operating force and shorter button travel.

### PANEL SEALED SWITCHES



An elastomer seal is bonded between actuating plunger and button collar. An O-ring seals the button assembly to the panel front.

Two-piece design enables button to be mounted separately. After switch unit is wired, it snaps into place from behind panel.

### ORDER GUIDE

Momentary action switches.

Button Color	Collar Type	No. of SPDT Circuits	
		1	2
Black	Hex	1PB4	2PB4
Black	Round	1PB42	—
Red	Round	1PB43	—

### ELECTRICAL RATINGS

(Except 15PB and 700PB)

30 VDC: 5 amps, res., sea level or 50,000 ft.; 3 amps, ind., sea level; 2.5 amps ind., 50,000 ft; 24 amps, max. inrush.

UL and CSA rating for basic switches: 5 amps, 125 or 250 VAC.

# Manual Switches

## Pushbutton Switches

PB Series

### WATERTIGHT SWITCH



### ORDER GUIDE

**Momentary action switches.**  
Has knurled chrome-finished facenut.

Button Color	No. of SPDT Circuits
Black	2PB901-T2

Facenut-to-panel, button-to-facenut, and bushing-to-facenut, sealing helps prevent entry of water from behind panel, up and over bushing wall. Switch units potted in corrosion resistant metal enclosure. Meets submergence requirements of MIL-STD-108 (up to 10 PSI water pressure for one hour).

### HERMETICALLY SEALED SWITCHES



These pushbuttons are equipped with HM hermetically sealed switch units, which have metal-to-metal fusion around the cover, actuator base, and mounting holes. Terminals are sealed glass-to-metal.

Vapor-proof construction enables use in damp locations without condensation on contacts. External parts corrosion resistant per MIL-S-8805. Meets explosion-proof requirements of MIL-S-8805.

### ORDER GUIDE

**Momentary action switches.**

Button Color	No. of SPDT Circuits	
	2	4
Black	702PB1	704PB1

### MINIATURE SIZE SWITCHES



1PB5



15PB2

### ORDER GUIDE

**Momentary action switches.**

Button	No. of SPDT Circuits	
	1	2
Steel*	1PB5	—
White Plastic	—	15PB2

\* Steel button enables use under hinged plates or paddle levers, in addition to manual operation.

### ELECTRICAL RATINGS — 700PB and 15PB

700PB (With hermetically sealed switch units):  
28 VDC and 115 VAC, 400 HZ: 3 amps, ind., 5 amps, res.

15PB:  
30 VDC and 115 VAC: 2 amps, ind., 5 amps, res.; 1.0 amp, lamp load.

**1PB5**  
250 VAC: 5 amps.

30 VDC: 5 amps, res., sea level or 50,000 ft.; 3 amps, ind., sea level; 2.5 amps ind., 50,000 ft.; 24 amps, max. inrush.

Pushbuttons

# Manual Switches

## Pushbutton Switches

PB Series

### MOUNTING DIMENSIONS (For reference only)

Touch Feedback Switches

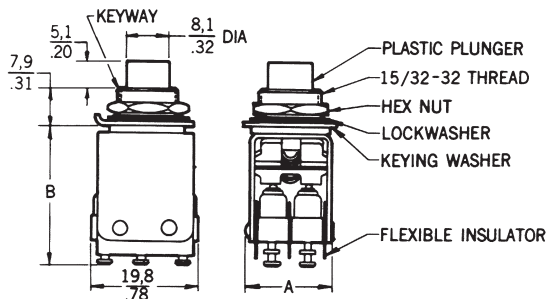

		2-Pole	4-Pole
Dim. "A" (max.)	Mom.	16,8/.66	30,0/1.18
	Alt. Act.	17,3/.68	30,5/1.20
Dim. "B"	Mom.	26,7/1.05	26,7/1.05
	Alt. Act.	33,0/1.34	33,0/1.34

Panel Sealed Switches

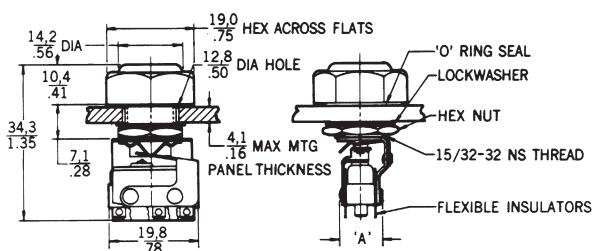
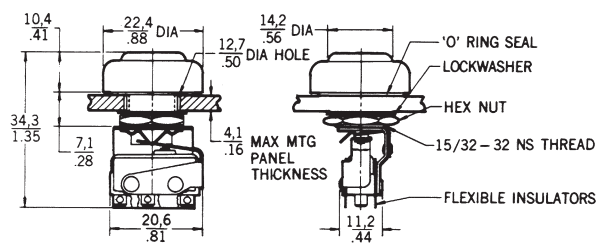

	1-Pole	2-Pole
Dim. "A" (max.)	11,7/.46	17,0/.67

Key: 0,0 = mm  
0.00 = inches

Short Travel Switches

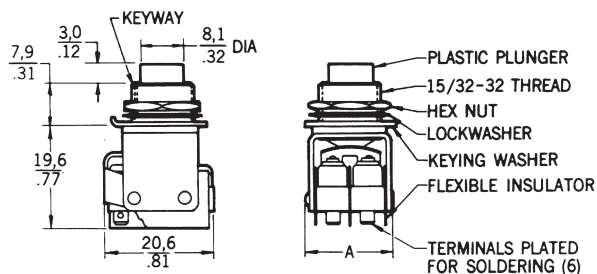

	2-Pole	3-Pole
Dim. "A" (max.)	17,0/.67	23,8/.94

# Manual Switches

## Pushbutton Switches

PB Series

### MOUNTING DIMENSIONS (For reference only)

Watertight Switch

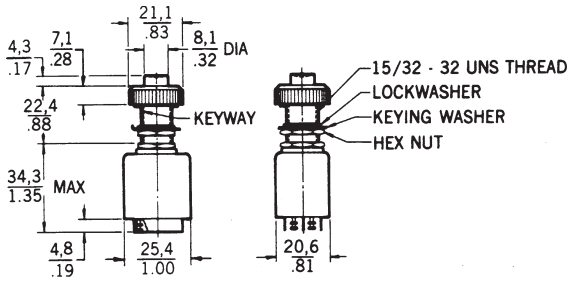

Miniature Size Switches

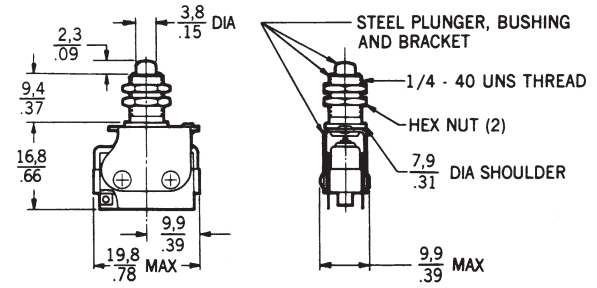

Hermetically Sealed Switches

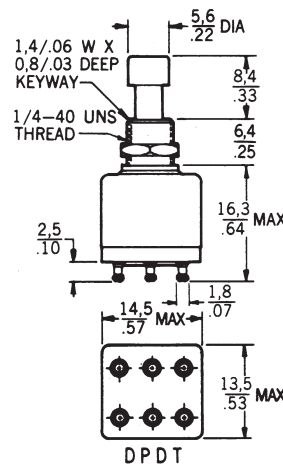
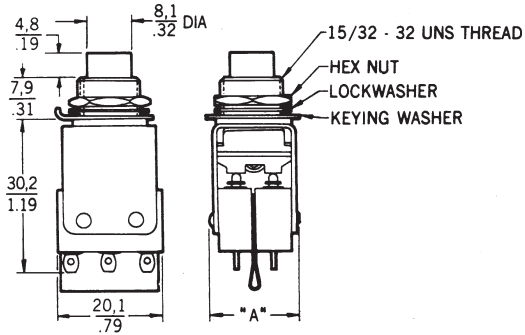

Mounting hardware includes:  
hexnut, lockwasher, and  
keying washer.

	2-Pole	4-Pole
Dim. "A" (max.)	16,8/.66	30,0/1.18

Key:  $\frac{0,0}{0.00} = \text{mm}$   
 $\frac{0.00}{0.00} = \text{inches}$

Pushbuttons