

Switch Amplifier

KFD2-SOT2-Ex1.LB

SIL 2

- 1-channel isolated barrier
- 24 V DC supply (Power Rail)
- Dry contact or NAMUR inputs
- Passive transistor output, non-polarized
- Passive fault output, non-polarized
- Line fault detection (LFD)
- Reversible mode of operation
- Up to SIL 2 acc. to IEC 61508



Function

This isolated barrier is used for intrinsic safety applications. It transfers digital signals (NAMUR sensors/mechanical contacts) from a hazardous area to a safe area. The proximity sensor or switch controls two passive transistors for the safe area load. The normal output state can be reversed using switch S1. Switch S2 allows output II to be switched between a signal output or an error message output. Switch S3 enables or disables line fault detection of the field circuit. During an error condition, the transistors revert to their de-energized state and LEDs indicate the fault according to NAMUR NE44. Eine Sammelfehlermeldung ist möglich, wenn das Gerät über Power Rail betrieben wird.

Technical Data

General specifications			
Signal type	Digital Input		
Functional safety related parameters			
Safety Integrity Level (SIL)	SIL 2		
Supply			
Connection	Power Rail or terminals 14+, 15-		
Rated voltage	U_r	20 ... 30 V DC	
Ripple	≤ 10 %		
Rated current	I_r	≤ 50 mA	
Input			
Connection side	field side		
Connection	terminals 1+, 2+, 3-		
Rated values	acc. to EN 60947-5-6 (NAMUR), see manual for electrical data		
Open circuit voltage/short-circuit current	approx. 8 V DC / approx. 8 mA		
Switching point/switching hysteresis	1.2 ... 2.1 mA / approx. 0.2 mA		
Line fault detection	breakage $I \leq 0.1$ mA , short-circuit $I > 6$ mA		
Output			
Connection side	control side		
Connection	output I: terminals 7, 8 ; output II: terminals 8, 9		
Switching voltage	max. 30 V		
Switching current	max. 100 mA , short-circuit protected		
Signal level	1-signal: switching voltage - 2.5 V max. at 10 mA switching current or 3 V max. at 100 mA switching current 0-signal: switched off (off-state current ≤ 10 μA)		
Output I	signal, passive electronic output		
Output II	signal or error message; passive transistor output		

Release date: 2020-04-06 Date of issue: 2020-04-06 Filename: 181002_eng.pdf

Refer to "General Notes Relating to Pepperl+Fuchs Product Information".

Pepperl+Fuchs Group
www.pepperl-fuchs.com

USA: +1 330 486 0002
pa-info@us.pepperl-fuchs.com

Germany: +49 621 776 2222
pa-info@de.pepperl-fuchs.com

Singapore: +65 6779 9091
pa-info@sg.pepperl-fuchs.com

PEPPERL+FUCHS

Technical Data

Collective error message		Power Rail
Transfer characteristics		
Switching frequency		≤ 5 kHz
Galvanic isolation		
Input/Output		reinforced insulation acc. to IEC 62103, rated insulation voltage 300 V _{rms}
Input/power supply		reinforced insulation acc. to IEC 62103, rated insulation voltage 300 V _{rms}
Output/power supply		basic insulation according to IEC 62103, rated insulation voltage 50 V _{eff}
Output/Output		not available
Indicators/settings		
Display elements		LEDs
Control elements		DIP-switch
Configuration		via DIP switches
Labeling		space for labeling at the front
Directive conformity		
Electromagnetic compatibility		
Directive 2014/30/EU		EN 61326-1:2013 (industrial locations)
Conformity		
Galvanic isolation		IEC 62103:2003
Electromagnetic compatibility		NE 21:2004
Degree of protection		IEC 60529:2001
Input		EN 60947-5-6:2000
Ambient conditions		
Ambient temperature		-20 ... 60 °C (-4 ... 140 °F)
Mechanical specifications		
Degree of protection		IP20
Connection		screw terminals
Mass		approx. 150 g
Dimensions		20 x 119 x 115 mm (0.8 x 4.7 x 4.5 inch) , housing type B2
Mounting		on 35 mm DIN mounting rail acc. to EN 60715:2001
Data for application in connection with hazardous areas		
EU-type examination certificate		PTB 00 ATEX 2035
Marking		⊕ II (1) G [Ex ia] IIC ⊕ II (1) D [Ex ia] IIIC
Input		Ex ia IIC, Ex ia IIIC
Voltage	U _o	10.5 V
Current	I _o	13 mA
Power	P _o	34 mW (linear characteristic)
Supply		
Maximum safe voltage	U _m	40 V DC (Attention! The rated voltage can be lower.)
Output		
Maximum safe voltage	U _m	40 V DC (Attention! The rated voltage can be lower.)
EU-type examination certificate		DMT 01 ATEX E 133
Marking		⊕ I (M1) [Ex ia] I
Certificate		TÜV 99 ATEX 1499 X
Marking		⊕ II 3G Ex nA II T4
Galvanic isolation		
Input/Output		safe electrical isolation acc. to IEC/EN 60079-11, voltage peak value 375 V
Input/power supply		safe electrical isolation acc. to IEC/EN 60079-11, voltage peak value 375 V
Directive conformity		
Directive 2014/34/EU		EN 60079-0:2012+A11:2013 , EN 60079-11:2012 , EN 60079-15:2010 , EN 50303:2000
International approvals		
FM approval		
Control drawing		116-0035

Release date: 2020-04-06 Date of issue: 2020-04-06 Filename: 181002_eng.pdf

Refer to "General Notes Relating to Pepperl+Fuchs Product Information".

Pepperl+Fuchs Group
www.pepperl-fuchs.comUSA: +1 330 486 0002
pa-info@us.pepperl-fuchs.comGermany: +49 621 776 2222
pa-info@de.pepperl-fuchs.comSingapore: +65 6779 9091
pa-info@sg.pepperl-fuchs.com

PEPPERL+FUCHS

Technical Data

CSA approval	
Control drawing	116-0047
IECEX approval	IECEX PTB 05.0011
Approved for	[Ex ia] IIC , [Ex ia] I , [Ex ia] IIIC
General information	
Supplementary information	Observe the certificates, declarations of conformity, instruction manuals, and manuals where applicable. For information see www.pepperl-fuchs.com .

Assembly

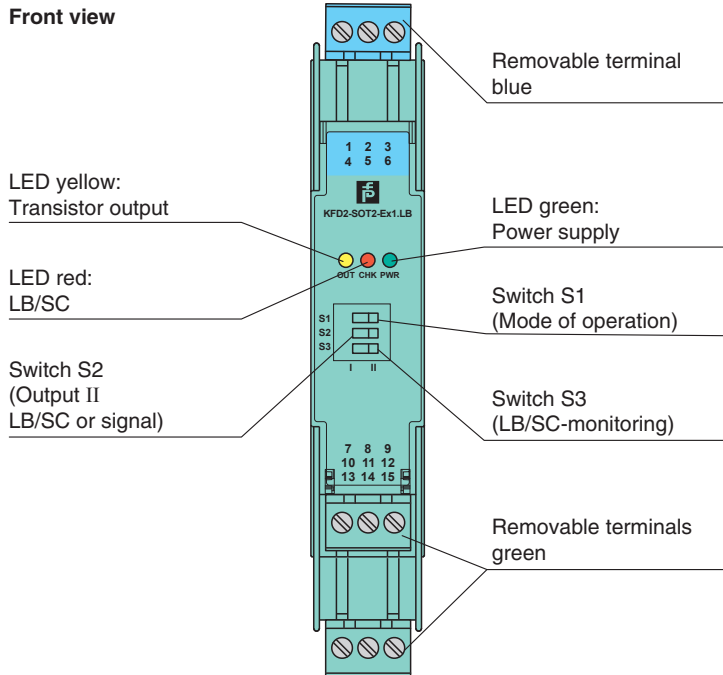

Connection

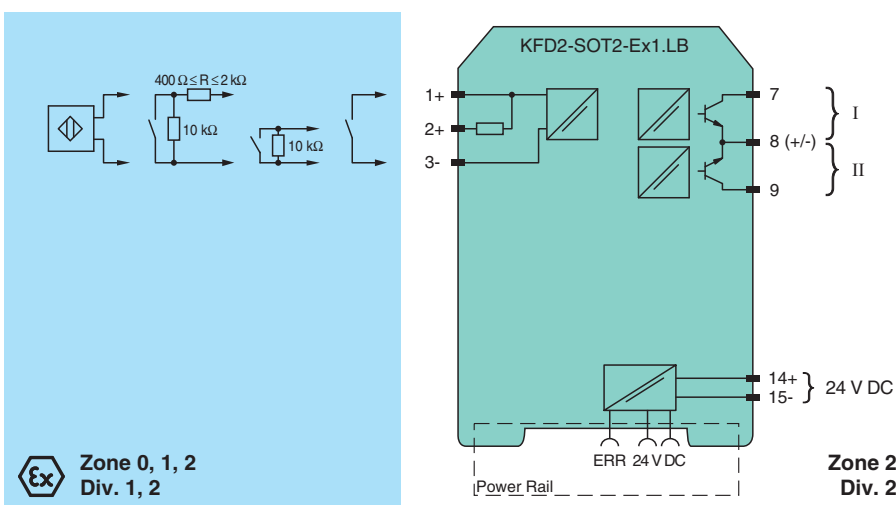





Accessories

	KFD2-EB2	Power Feed Module
--	-----------------	-------------------

Release date: 2020-04-06 Date of issue: 2020-04-06 Filename: 181002_eng.pdf

Accessories

	UPR-03	Universal Power Rail with end caps and cover, 3 conductors, length: 2 m
	UPR-03-M	Universal Power Rail with end caps and cover, 3 conductors, length: 1,6 m
	UPR-03-S	Universal Power Rail with end caps and cover, 3 conductors, length: 0.8 m
	K-DUCT-BU	
	K-DUCT-BU-UPR-03	Profile rail with UPR-03- * insert, 3 conductors, wiring comb field side blue

Configuration

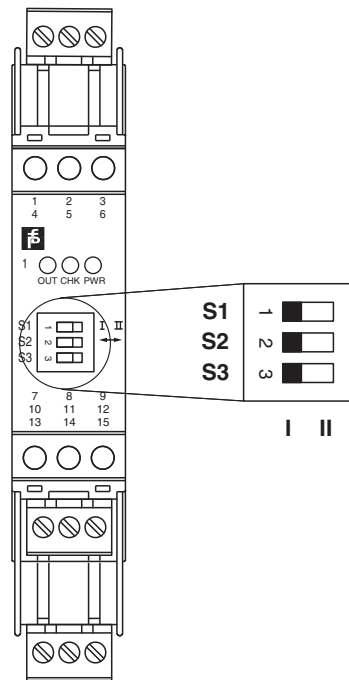

Switch position

S	Function		Position
1	Mode of operation output I active	with high input current	I
		with low input current	II
2	Assignment output II	Switching state like output I	I
		Fault indication output (passive if fault)	II
3	Line fault detection	ON	I
		OFF	II

Operating states

Control circuit	Input signal
Initiator high impedance/contact opened	low input current
Initiator low impedance/contact closed	high input current
Lead breakage, lead short circuit	Line fault

Factory setting: switch 1, 2 and 3 in position I

Release date: 2020-04-06 Date of issue: 2020-04-06 Filename: 181002_eng.pdf