

WL250-S132

W250

COMPACT PHOTOELECTRIC SENSORS

SICK
Sensor Intelligence.



Illustration may differ



Ordering information

Type	Part no.
WL250-S132	6010611

Included in delivery: P250 (1), BEF-W250 (1)

Other models and accessories → www.sick.com/W250

Detailed technical data

Features

Sensor/ detection principle	Photoelectric retro-reflective sensor
Dimensions (W x H x D)	20 mm x 60 mm x 43 mm
Housing design (light emission)	Rectangular
Sensing range max.	0.01 m ... 13.5 m ¹⁾
Sensing range	0.01 m ... 8 m ²⁾ 0.01 m ... 11 m ¹⁾
Type of light	Visible red light
Light source	LED ³⁾
Light spot size (distance)	Ø 400 mm (8 m)
Angle of dispersion	2.5°
Adjustment	Potentiometer, 2 turns ⁴⁾

¹⁾ Reflector PL80A.

²⁾ Reflector P250.

³⁾ Average service life: 100,000 h at T_J = +25 °C.

⁴⁾ With position indicator.

Mechanics/electronics

Supply voltage	12 V DC ... 240 V DC ¹⁾ 24 V AC/DC ... 240 V AC/DC ¹⁾
-----------------------	--

¹⁾ ±10 %.

²⁾ Provide suitable spark suppression for inductive or capacitive loads.

³⁾ With light/dark ratio 1:1.

⁴⁾ Do not bend below 0 °C.

⁵⁾ A = V_S connections reverse-polarity protected.

⁶⁾ C = interference suppression.

⁷⁾ Reference voltage: 250 V AC.

Power consumption	≤ 2 VA
Switching output	Relay, electrically isolated ²⁾
Output function	Change-over contacts
Switching mode	Light switching ²⁾
Switching current (switching voltage)	3 A (240 V AC) 3 A (30 V DC)
Response time	≤ 15 ms
Switching frequency	33 Hz ³⁾
Connection type	Cable, 5-wire, 2 m ⁴⁾
Cable material	PVC
Conductor cross-section	0.76 mm ²
Cable diameter	Ø 6.3 mm
Circuit protection	A ⁵⁾ C ⁶⁾
Protection class	II ⁷⁾
Weight	160 g
Polarisation filter	✓
Housing material	Plastic, ABS
Optics material	Plastic, PMMA
Enclosure rating	IP67
Items supplied	Reflector P250, BEF-W250 mounting bracket
Usage category	AC-15, DC-13, according to EN 60947-1
Ambient operating temperature	-25 °C ... +55 °C
Ambient storage temperature	-40 °C ... +70 °C
UL File No.	NRNT2.E128350 & NRNT8.E128350

¹⁾ ±10 %.

²⁾ Provide suitable spark suppression for inductive or capacitive loads.

³⁾ With light/dark ratio 1:1.

⁴⁾ Do not bend below 0 °C.

⁵⁾ A = V_S connections reverse-polarity protected.

⁶⁾ C = interference suppression.

⁷⁾ Reference voltage: 250 V AC.

Classifications

ECl@ss 5.0	27270902
ECl@ss 5.1.4	27270902
ECl@ss 6.0	27270902
ECl@ss 6.2	27270902
ECl@ss 7.0	27270902
ECl@ss 8.0	27270902
ECl@ss 8.1	27270902
ECl@ss 9.0	27270902
ECl@ss 10.0	27270902

ECl@ss 11.0	27270902
ETIM 5.0	EC002717
ETIM 6.0	EC002717
ETIM 7.0	EC002717
UNSPSC 16.0901	39121528

Connection diagram

Cd-163

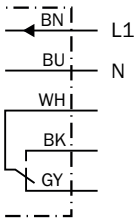

Characteristic curve

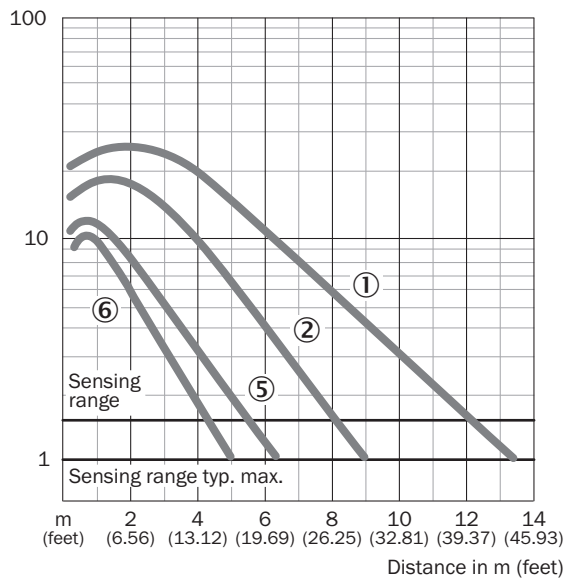

Sensing range diagram

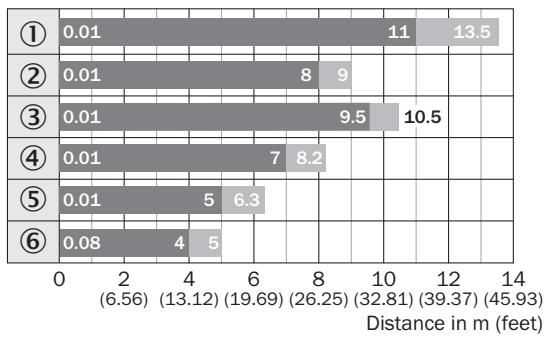

■ Sensing range ■ Sensing range typ. max.

Reflector type

- ① PL80A
- ② P250
- ③ PL50A/PL40A
- ④ PL30A/PL31A
- ⑤ PL20A
- ⑥ Reflective tape
Diamond Grade

Adjustments possible

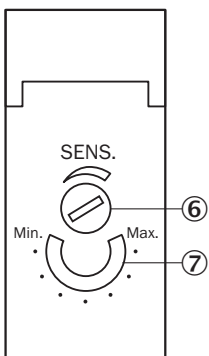

- ⑥ Sensitivity adjustment (2 turns), over-turn protection
- ⑦ Position indicator for sensitivity setting (270°)

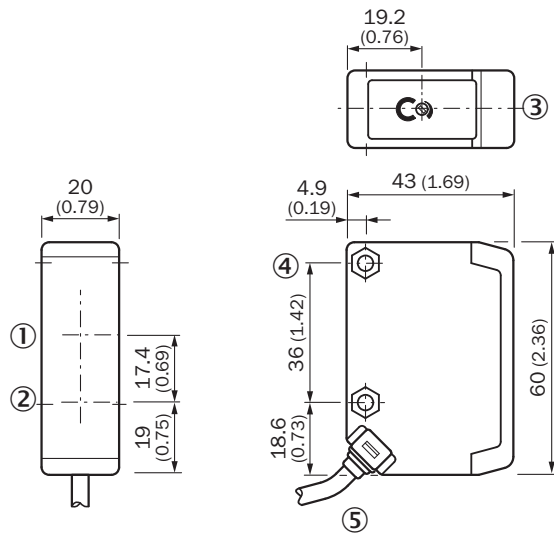

Dimensional drawing (Dimensions in mm (inch))



- ① Reception axis
- ② Transmission axis
- ③ LED reception indicator, red
- ④ Mounting hole \varnothing 4.2 mm, for M4 hexagon nuts on both sides
- ⑤ Connection cable

Recommended accessories

Other models and accessories → www.sick.com/W250

	Brief description	Type	Part no.
Mounting brackets and plates			
	Universal mounting bracket for reflectors, steel, zinc coated	BEF-WN-REFX	2064574
Plug connectors and cables			
	Head A: male connector, M12, 5-pin, straight Cable: unshielded For field bus technology	STE-1205-G	6022083
Reflectors			
	Rectangular, screw connection, 47 mm x 47 mm, PMMA/ABS, Screw-on, 2 hole mounting	P250	5304812

SICK AT A GLANCE

SICK is one of the leading manufacturers of intelligent sensors and sensor solutions for industrial applications. A unique range of products and services creates the perfect basis for controlling processes securely and efficiently, protecting individuals from accidents and preventing damage to the environment.

We have extensive experience in a wide range of industries and understand their processes and requirements. With intelligent sensors, we can deliver exactly what our customers need. In application centers in Europe, Asia and North America, system solutions are tested and optimized in accordance with customer specifications. All this makes us a reliable supplier and development partner.

Comprehensive services complete our offering: SICK LifeTime Services provide support throughout the machine life cycle and ensure safety and productivity.

For us, that is “Sensor Intelligence.”

WORLDWIDE PRESENCE:

Contacts and other locations –www.sick.com