



Product availability : Stock - Normally stocked in distribution facility



### Main

Range of product	Harmony XB4
Product or component type	Head for selector switch
Device short name	ZB4
Bezel material	Chromium plated metal
Mounting diameter	0.87 in (22 mm)
Sale per indivisible quantity	1
Shape of signaling unit head	Round
Type of operator	Spring return to centre
Operator profile	Black long handle
Operator additional information	Non padlockable
Operator position information	3 positions +/- 45°

### Complementary

CAD overall width	1.14 in (29 mm)
CAD overall height	1.5 in (38 mm)
CAD overall depth	1.73 in (44 mm)
Product weight	0.09 lb(US) (0.04 kg)
Resistance to high pressure washer	1015.26 psi (7000000 Pa) at 131 °F (55 °C), distance: 0.1 m
Mechanical durability	1000000 cycles
Electrical composition code	C11 <= 3 contacts using single blocks in front mounting C3 <= 6 contacts using single blocks in front mounting C4 <= 6 contacts using single and double blocks in front mounting C7 <= 4 contacts using single blocks in front mounting C8 <= 4 contacts using single and double blocks in front mounting C5 <= 5 contacts using single blocks in front mounting C6 <= 5 contacts using single and double blocks in front mounting

## Environment

Protective treatment	TH
Ambient air temperature for storage	-40...158 °F (-40...70 °C)
Ambient air temperature for operation	-40...158 °F (-40...70 °C)
Overvoltage category	Class I conforming to IEC 60536
IP degree of protection	IP69 IP67 conforming to IEC 60529 IP69K
NEMA degree of protection	NEMA 13 NEMA 4X
IK degree of protection	IK06 conforming to IEC 50102
Standards	JIS C 4520 EN/IEC 60947-5-4 EN/IEC 60947-5-1 EN/IEC 60947-1 EN/IEC 60947-5-5 UL 508 CSA C22.2 No 14
Product certifications	RINA LROS (Lloyds register of shipping) CSA GL DNV BV UL listed
Vibration resistance	5 gn (f = 2...500 Hz) conforming to IEC 60068-2-6
Shock resistance	30 gn (duration = 18 ms) half sine wave acceleration conforming to IEC 60068-2-27 50 gn (duration = 11 ms) half sine wave acceleration conforming to IEC 60068-2-27

## Ordering and shipping details

Category	22468 - PUSHBUTTONS,22MM(METAL) NEW
Discount Schedule	CS2
GTIN	00785901354642
Nbr. of units in pkg.	1
Package weight(Lbs)	0.10000000000000001
Returnability	Y
Country of origin	FR

## Contractual warranty

Warranty period	18 months
-----------------	-----------

Dimensions

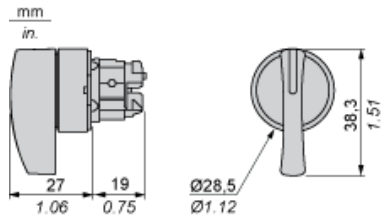

Panel Cut-out for Pushbuttons, Switches and Pilot Lights (Finished Holes, Ready for Installation)

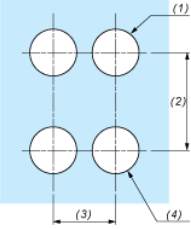
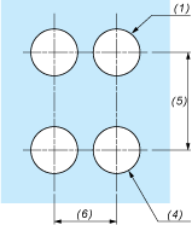
Connection by Screw Clamp Terminals or Plug-in Connectors or on Printed Circuit Board	Connection by Faston Connectors
	
<p>(1) Diameter on finished panel or support                  (2) 40 mm min. / 1.57 in. min.                  (3) 30 mm min. / 1.18 in. min.                  (4) <math>\varnothing 22.5</math> mm / 0.89 in. recommended (<math>\varnothing 22.3</math> mm <math>_{0}^{+0.4}</math> / 0.88 in. <math>_{0}^{+0.016}</math>)                  (5) 45 mm min. / 1.78 in. min.                  (6) 32 mm min. / 1.26 in. min.</p>	



Dimensions in in.



A: 1.18 in. min.  
 B: 1.57 in. min.

### General Tolerances of the Panel and Printed Circuit Board

The cumulative tolerance must not exceed 0.3 mm / 0.012 in:  $T1 + T2 = 0.3 \text{ mm max.}$

### Installation Precautions

- Minimum thickness of circuit board: 1.6 mm / 0.06 in.
- Cut-out diameter: 22.4 mm  $\pm$  0.1 / 0.88 in.  $\pm$  0.004
- Orientation of body/fixing collar ZB4 BZ009:  $\pm 2^\circ 30'$  (excluding cut-outs marked a and b).
- Tightening torque of screws ZBZ 006: 0.6 N.m (5.3 lbf.in) max.
- Allow for one ZB4 BZ079 fixing collar/pillar and its fixing screws:
  - every 90 mm / 3.54 in. horizontally (X), and 120 mm / 4.72 in. vertically (Y).
  - with each selector switch head (ZB4 BD\*, ZB4 BJ\*, ZB4 BG\*).

The fixing centers marked a and b are diagonally opposed and must align with those marked 4 and 5.

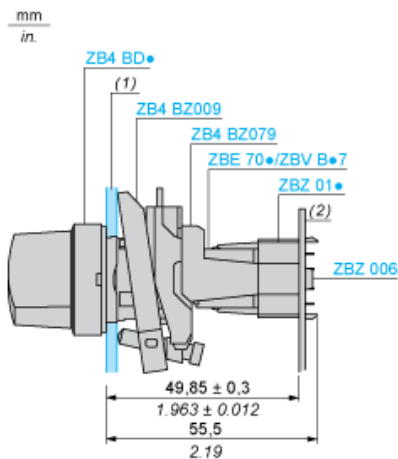

- (1) Panel  
 (2) Printed circuit board

## Mounting of Adapter (Socket) ZBZ 01•

- 1 2 elongated holes for ZBZ 006 screw access
- 2 1 hole  $\varnothing$  2.4 mm  $\pm$  0.05 / 0.09 in.  $\pm$  0.002 for centring adapter ZBZ 01•
- 3 8  $\times$   $\varnothing$  1.2 mm / 0.05 in. holes
- 4 1 hole  $\varnothing$  2.9 mm  $\pm$  0.05 / 0.11 in.  $\pm$  0.002, for aligning the printed circuit board (with cut-out marked a)
- 5 1 elongated hole for aligning the printed circuit board (with cut-out marked b)
- 6 4 holes  $\varnothing$  2.4 mm / 0.09 in. for clipping in adapter ZBZ 01•

Dimensions An + 18.1 relate to the  $\varnothing$  2.4 mm  $\pm$  0.05 / 0.09 in.  $\pm$  0.002 holes for centring adapter ZBZ 01•.

---

Electrical Composition Corresponding to Code C3

---

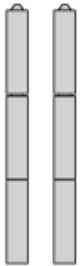

---

Electrical Composition Corresponding to Code C4

---

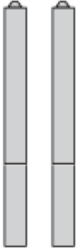

---

Electrical Composition Corresponding to Code C5

---

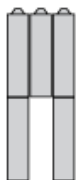

---

Electrical Composition Corresponding to Code C6

---



---

Electrical Composition Corresponding to Code C7

---

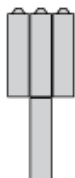

---

Electrical Composition Corresponding to Code C8

---

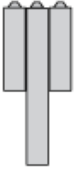

---

Electrical Composition Corresponding to Codes C9, C11, SF1 and SR1

---



---

Legend

---

Single contact



Double contact



Light block



Possible location



Sequence of Contacts Fitted to 3-position Selector Switch Body

Position 315°



Push	Position	Top			
Bottom					
Location		Left	Centre	Right	
State		1	1	0	
Contacts	N/O		closed	closed	open
N/C		open	open	closed	

Position 0°



Push	Position	Top			
Bottom					
Location		Left	Centre	Right	
State		0	0	0	
Contacts	N/O		open	open	open
N/C		closed	closed	closed	

Position 45°



Push	Position	Top			
Bottom					
Location		Left	Centre	Right	
State		0	1	1	
Contacts	N/O		open	closed	closed
N/C		closed	open	open	