



Model Number

V11-G-2M-PVC-V11-W

Connecting cable, M12 to M12, PVC cable 3-pin

Features

- Knurled nut suitable for tool assembly
- Immunity to vibration, with mechanical latching
- Gold-plated and machined contacts
- Degree of protection IP67 / IP68 / IP69K
- Suitable for 2- and 3-wire technology

Dimensions

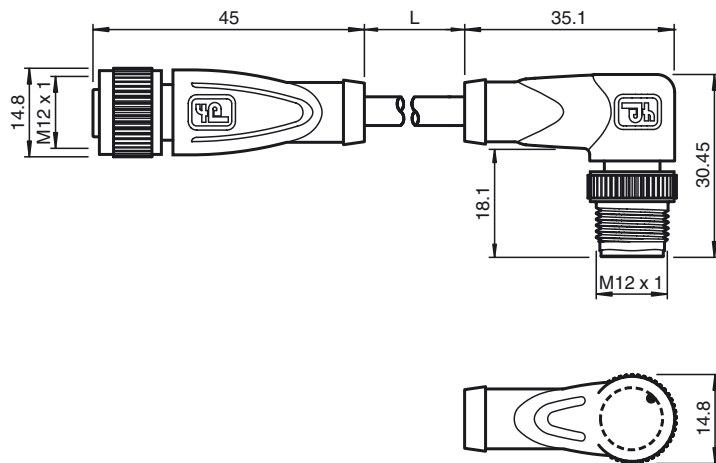

Technical data

General specifications

Number of pins 3

Electrical specifications

Operating voltage U_B max. 300 V DC
 Test voltage > 1500 V_{eff} AC
 Operating current I_B max. 4 A
 Volume resistance < 5 mΩ

Ambient conditions

Ambient temperature -25 ... 100 °C (-13 ... 212 °F)
 for temperatures over 80 °C (176 °F) reduced elongation at tear
 Pollution degree 3

Mechanical specifications

Contact elements spring-loaded contact socket
 Pin diameter 1 mm
 Degree of protection IP67 / IP68 / IP69k
 Material
 Contacts CuSn / Au
 Contact surface Au
 Body TPU, green
 Cable PVC
 Slotted nut Diecast zinc
 Sleeve connector Diecast zinc
 Core insulation PVC
 Cable fine-strand, flexible
 Sheath diameter Ø4.8 mm
 Bending radius > 10 x cable diameter, moving
 Color grey
 Cores 3 x 0.34 mm²
 Conductor construction 19 x 0.15 mm Ø
 Length L 2 m
 Flammability
 Contact carrier 94 V-2
 Housing 94 V-2

Electrical connection

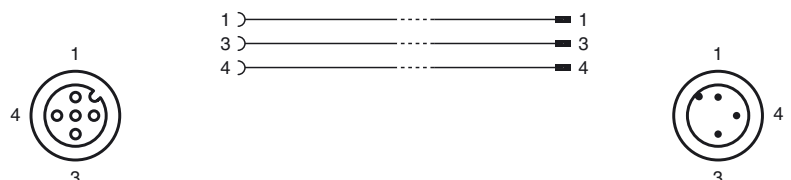

Release date: 2017-02-16 11:43 Date of issue: 2017-02-16 129950_eng.xml