



### Model Number

UBE500-F64-SE2-V3

### Features

- Reliable detection of transparent materials
- High switching frequency
- Small angle of divergence
- Small, compact design
- Plastic housing
- Emitter and receiver included in the delivery package

### Curves

#### Characteristic response curves

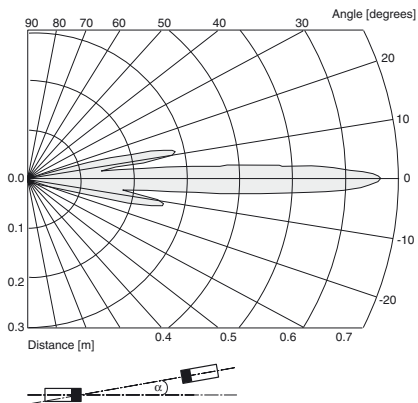

### Technical data

#### General specifications

Sensing range	0 ... 500 mm , distance emitter-receiver 15 mm ... 500 mm
Transducer frequency	200 kHz
Reference target	receiver

#### Indicators/operating means

LED yellow	indication of the switching state (receiver)
------------	--

#### Electrical specifications

Operating voltage $U_B$	18 ... 30 V DC , ripple 10 % <sub>SS</sub>
No-load supply current $I_0$	20 mA receiver 12 mA emitter

#### Output

Output type	1 switch output E2, pnp NO
Rated operational current $I_e$	200 mA
Voltage drop $U_d$	$\leq 2$ V
Switch-on delay $t_{on}$	$< 5$ ms
Switching frequency $f$	100 Hz

#### Ambient conditions

Ambient temperature	0 ... 60 °C (273 ... 333 K)
Storage temperature	-40 ... 85 °C (233 ... 358 K)

#### Mechanical specifications

Protection degree	IP54
Connection	V3 connector (M8 x 1), 3 pin
Material	
Housing	PA 6.6
Mass	80 g per device

#### Compliance with standards and directives

Standard conformity	
Standards	EN 60947-5-2:2007 IEC 60947-5-2:2007

**Dimensions**

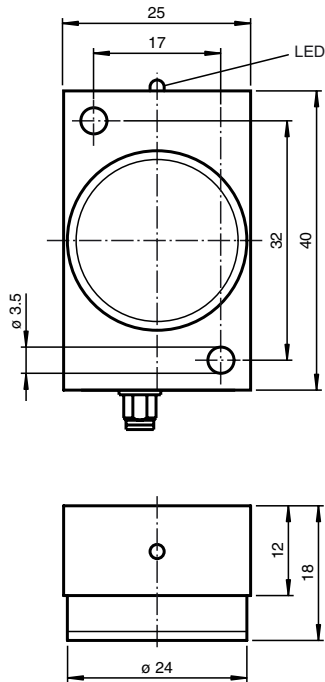

**Electrical Connection**

**Standard symbol/Connection:**

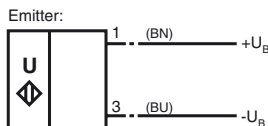
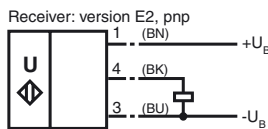
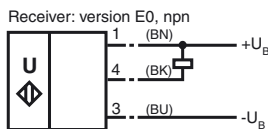

Core colours in accordance with EN 60947-5-2.

**Pinout**

**Connector V3**



**Function**

A through-beam ultrasonic barrier always consists of a single emitter and a single receiver. The function of a through-beam ultrasonic barrier is based in the interruption of the sound transmission to the receiver by the object to be detected. The emitter sends an ultrasonic signal that is evaluated by the receiver. If the signal is interrupted or muted by the object to be detected, the receiver switches. No electrical connections are required between the emitter and receiver. The function of through-beam ultrasonic barriers is not dependent on the position of their installation. We recommend, however, to install the emitter below in the case

**Additional Information**

**Mounting/Adjustment**

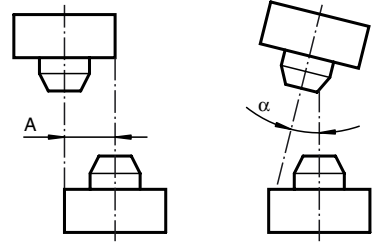

Parallel displacement  
A ≤ 8 mm

Angle displacement  
 $\alpha \leq 5^\circ$

**Thin foil detection**

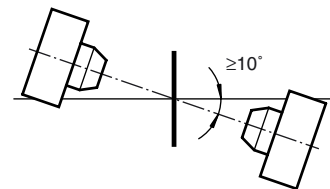

of vertical installations to prevent the accumulation of dust particles.

**Installation tolerances**

The installation tolerances of the central axes of the emitter and receiver may not exceed the values specified in the illustration.

**Detection of thin foils**

For the detection of thin foils (< 0.1 mm), install the through-beam ultrasonic barrier at an angle of  $\geq 10^\circ$  from perpendicular to the foil.

**Caution**

Mount or replace emitter and receiver only in pairs. Both devices are optimally matched to each other by the manufacturer.

## Accessories

**Mating connectors**

V3-GM-5M-PUR

V3-WM-2M-PUR

For further information refer to chapter „Accessories“.