

Alternative article: RV3500

When selecting an alternative article and accessories please note that technical data may differ!

efector 400

RV1036



RV-2500-I05/L2

Encoders

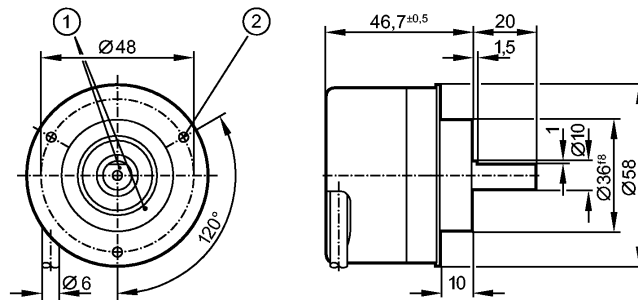

1: reference mark
2: M3 5 mm deep



Product characteristics

Solid shaft encoder

TTL output 20 mA

Cable

6 signals

Resolution 2500

Electrical data

Operating voltage [V]

5 DC ± 0.5

Current consumption [mA]

< 120

Phase difference A und B [°]

90

Switching frequency [kHz]

300

Pulse diagram

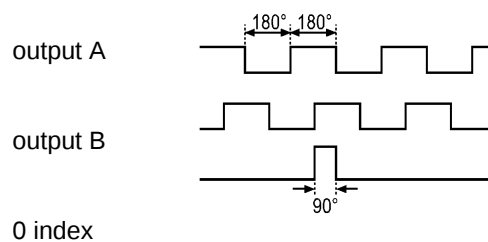

Outputs

Output function

TTL output 20 mA

Measuring / setting range

Encoders

Resolution

2500

Mechanical data

Max. permissible rpm / mech. [1/min]

12000

Starting torque [Ncm]

< 1 (20 °C)

Max. shaft load (at the shaft end) [N]

axial 10; radial 20

Shaft, material [mm]

Ø 10, steel (1.4104)

Vibration resistance

30 g

Shock resistance

200 g

Housing materials

aluminum

Weight [kg]

0.46

Environment

Max. relative air humidity [%]

max. 98

Ambient temperature [°C]

-40...100, -40 °C for firmly laid cable

RV1036 - Solid shaft encoder - eclass: 27270590 / 27-27-05-90

Protection		IP 64; IP 67 (housing); IP 64 (shaft)
Tests / approvals		
MTTF	[Years]	190
Electrical connection		
Connection		PUR cable / 2 m; radial, can also be used axially
Max. cable length	[m]	100
Wiring		
brown:	A	
green:	A (inv.)	
grey:	B	
pink:	B (inv.)	
red:	0 index	
black:	0 index (inv.)	
blue:	L+ (sensor)	
white:	0V (sensor)	
brown/green:	L+ (Up)	
white/green:	0V (Un)	
lilac:	error (inv.)	
screen:	housing	
Remarks		
Pack quantity	[piece]	1

ifm efector, inc. • 1100 Atwater Drive • Malvern • PA 19355 — We reserve the right to make technical alterations without prior notice. — US — RV1036 — 01.09.2010

Alternative article: RV3500

When selecting an alternative article and accessories please note that technical data may differ!