



Product availability : Stock - Normally stocked in distribution facility



Main

Range of product	Zelio Control
Product or component type	Industrial measurement and control relays
Relay type	Control relay
Product specific application	For 3-phase supply
Relay name	RM4-T
Relay monitored parameters	Phase sequence Phase failure detection
Time delay type	Without
Measurement range	198...484 V
Contacts type and composition	2 C/O
Poles description	3P

Complementary

Output contacts	2 C/O
Setting accuracy of time delay	10 P
Run-up delay at power-up	< 650 ms
Measuring cycle	<= 80 ms
Marking	CE
Overvoltage category	III conforming to IEC 60664-1
[Ui] rated insulation voltage	500 V conforming to IEC
Supply frequency	50/60 Hz +/- 5 %
Operating position	Any position without
Connections - terminals	Screw terminals 2 x 1.5 mm ² , flexible cable with cable end Screw terminals 2 x 2.5 mm ² , flexible cable without cable end
Tightening torque	5.31...9.73 lbf.in (0.6...1.1 N.m)
Mechanical durability	<= 30000000 cycles

[Ith] conventional free air thermal current	8 A
[Ie] rated operational current	2 A at 158 °F (70 °C) 24 V DC-13 conforming to IEC 60947-5-1/1991 2 A at 158 °F (70 °C) 24 V DC-13 conforming to VDE 0660 3 A at 158 °F (70 °C) 115 V AC-15 conforming to IEC 60947-5-1/1991 3 A at 158 °F (70 °C) 115 V AC-15 conforming to VDE 0660 3 A at 158 °F (70 °C) 24 V AC-15 conforming to IEC 60947-5-1/1991 3 A at 158 °F (70 °C) 24 V AC-15 conforming to VDE 0660 3 A at 158 °F (70 °C) 250 V AC-15 conforming to IEC 60947-5-1/1991 3 A at 158 °F (70 °C) 250 V AC-15 conforming to VDE 0660 0.1 A at 158 °F (70 °C) 250 V DC-13 conforming to IEC 60947-5-1/1991 0.1 A at 158 °F (70 °C) 250 V DC-13 conforming to VDE 0660 0.3 A at 158 °F (70 °C) 115 V DC-13 conforming to IEC 60947-5-1/1991 0.3 A at 158 °F (70 °C) 115 V DC-13 conforming to VDE 0660
Switching capacity in mA	10 mA at 12 V
Switching voltage	<= 440 V AC 250 V AC
Contacts material	90/10 silver nickel contacts
Number of cables	2
Height	3.07 in (78 mm)
Width	0.89 in (22.5 mm)
Depth	3.15 in (80 mm)
Terminals description ISO n°1	(L1-L2-L3)CO (15-16-18)OC (25-26-28)OC ALT
Output relay state	Tripped, fault present
9 mm pitches	2.5
Product weight	0.24 lb(US) (0.11 kg)
Terminals description ISO n°2	(21-22-24)OC (11-12-14)OC ALT (L1-L2-L3)CO

Environment

Electromagnetic compatibility	Electrostatic discharge - test level 6 kV, level 3 - contact discharge conforming to IEC 61000-4-2 Electrostatic discharge - test level 8 kV, level 3 - air discharge conforming to IEC 61000-4-2 Resistance to electrostatic discharge - test level 6 kV - contact conforming to IEC 61000-4-2 level 3 Resistance to electrostatic discharge - test level 8 kV - air conforming to IEC 61000-4-2 level 3
Standards	EN/IEC 60255-6
Product certifications	GL UL CSA
Directives	73/23/EEC - low voltage directive 89/336/EEC - electromagnetic compatibility
Ambient air temperature for storage	-40...185 °F (-40...85 °C)
Ambient air temperature for operation	-4...149 °F (-20...65 °C)
Relative humidity	15...85 % 3K3 conforming to IEC 60721-3-3
Vibration resistance	0.35 ms (f = 10...55 Hz) conforming to IEC 60068-2-6
Shock resistance	15 gn 11 ms conforming to IEC 60068-2-27
IP degree of protection	IP20(Terminals) conforming to IEC 60529 IP50 (casing) conforming to IEC 60529
Pollution degree	3 conforming to IEC 60664-1
Dielectric test voltage	2.5 kV
Non-dissipating shock wave	4.8 kV
Resistance to electrostatic discharge	6 kV contact conforming to IEC 61000-4-2 level 3 8 kV air conforming to IEC 61000-4-2 level 3
Resistance to electromagnetic fields	9.14 V/yd (10 V/m) conforming to IEC 61000-4-3 level 3
Resistance to fast transients	2 kV conforming to IEC 61000-4-4 level 3
Disturbance radiated/conducted	CISPR 22 - class A CISPR 11 group 1 - class A

Ordering and shipping details

Category	22376 - RELAYS-MEASUREMENT(RM4)
Discount Schedule	CP2
GTIN	00785901481638
Nbr. of units in pkg.	1
Package weight(Lbs)	0.28000000000000003
Returnability	N
Country of origin	ID

Contractual warranty

Warranty period	18 months
-----------------	-----------

3-phase Supply Control Relays

Dimensions

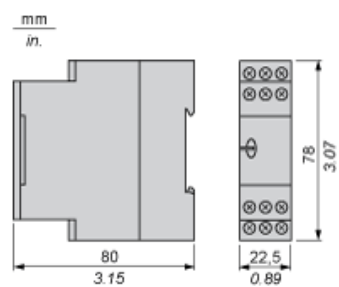

3-phase Supply Control Relays

Rail mounting

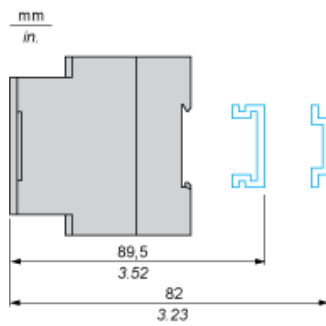

Screw fixing

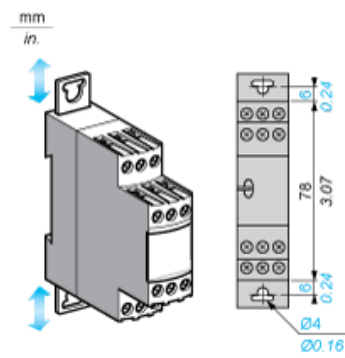

3-Phase Supply Control Relays

Wiring Diagram

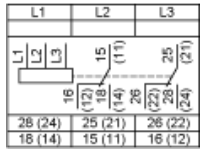

L1, L2 supply to be monitored
15 (11) - 18 (14) contact of the output relay
25 (21) - 26 (22), 25 (21) - 26 (22) output relay

Application Scheme

Example

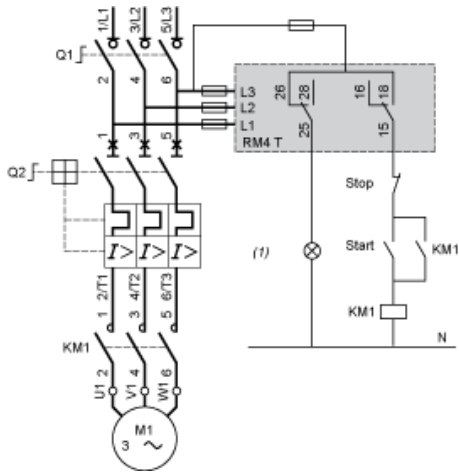

(1) Fault

Electrical Durability and Load Limit Curves

AC Load

Curve 1: Electrical durability of contacts on resistive load in millions of operating cycles

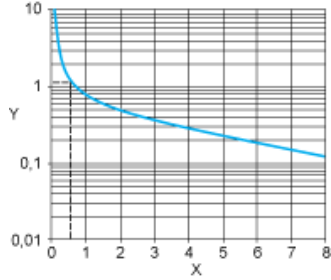

X Current broken in A
Y Millions of operating cycles

Curve 2: Reduction factor k for inductive loads (applies to values taken from durability Curve 1)

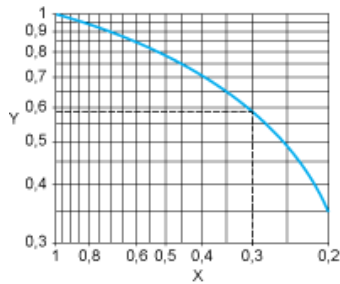

X Power factor on breaking (cos φ)
Y Reduction factor K

DC Load

Load limit curve

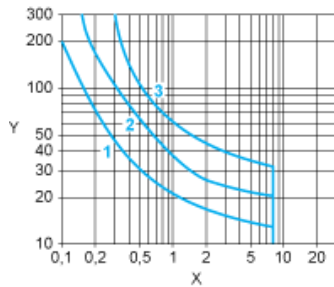

X Current in A
Y Voltage in V
1 L/R = 20 ms
2 L/R with load protection diode
3 Resistive load

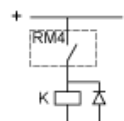

Product Life Status

END OF COMMERCIALIZATION