

Article discontinued as of 31.March 2016

efector 400[®]

RC6014



RC-0500-I24/L2

Encoders

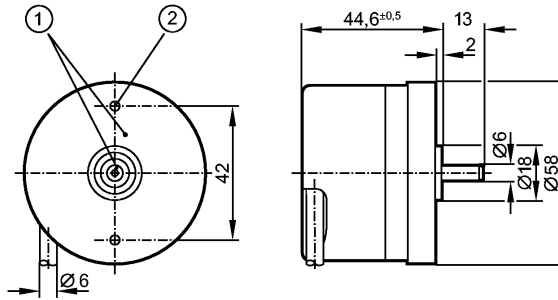

1: reference mark
2: M3 5 mm deep



Product characteristics

Solid shaft encoder

HTL-output 50 mA, short-circuit protected, < 1 min

Cable

6 signals

Resolution 500

Electrical data

Operating voltage [V]

10...30 DC

Current consumption [mA]

< 150

Phase difference A und B [°]

90

Switching frequency [kHz]

300

Pulse diagram

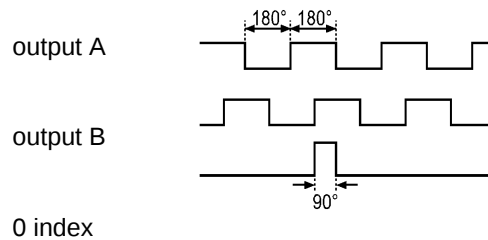

Outputs

Output function

HTL-output 50 mA, short-circuit protected, < 1 min

Measuring / setting range

Encoders

Resolution

500

Mechanical data

Max. permissible rpm / mech. [1/min]

16000

Starting torque [Ncm]

< 1 (20 °C)

Max. shaft load (at the shaft end) [N]

axial 10; radial 20

Shaft, material [mm]

Ø 6, steel (1.4104)

Vibration resistance

30 g

Shock resistance

200 g

Housing materials

aluminum

Weight [kg]

0.479

Environment

Max. relative air humidity [%]

max. 98

Ambient temperature [°C]

-40...100, -40 °C for firmly laid cable

Protection

IP 64; IP 67 (housing); IP 64 (shaft)

Tests / approvals

RC6014 - Solid shaft encoder - eclass: 27270590 / 27-27-05-90

MTTF	[Years]	190
Electrical connection		
Connection		PUR cable / 2 m; radial, can also be used axially
Max. cable length	[m]	300
Wiring		
brown:	A	
green:	A (inv.)	
grey:	B	
pink:	B (inv.)	
red:	0 index	
black:	0 index (inv.)	
blue:	L+ (sensor)	
white:	0V (sensor)	
brown/green:	L+ (Up)	
white/green:	0V (Un)	
lilac:	error (inv.)	
screen:	housing	
Remarks		
Pack quantity	[piece]	1

ifm efector, inc. • 1100 Atwater Drive • Malvern • PA 19355 — We reserve the right to make technical alterations without prior notice. — US — RC6014 — 12.03.2015
 Article discontinued as of 31.March 2016