



Model Number

NMB2-12GM40-Z0-C-FE-300MM-V1

Features

- Stainless steel sensing face
- Sensing range 2 mm
- 2-wire DC
- Weld field immune
- Weld slag resistant coating
- Ferrous targets

Accessories

V1-G-OR2M-POC

Female cordset, M12, 4-pin, TPE cable, welding-bead resistant

AB-12

Mounting aid

Technical Data

General specifications

Switching function	Normally open (NO)
Output type	Two-wire
Rated operating distance	s_n 2 mm
Installation	flush
Output polarity	DC
Assured operating distance	s_a 0 ... 1.62 mm
Actuating element	Ferrous targets
Reduction factor r_{Al}	0
Reduction factor r_{Cu}	0
Reduction factor r_{304}	0.6 - 0.8
Reduction factor r_{317}	1
Reduction factor r_{Brass}	0
Output type	2-wire

Nominal ratings

Operating voltage	U_B	6 ... 30 V DC
Switching frequency	f	0 ... 5 Hz
Hysteresis	H	3 ... 15 typ. 5 %
Reverse polarity protection		reverse polarity protected
Short-circuit protection		no
Voltage drop	U_d	≤ 5.5 V DC
Operating current	I_L	2 ... 100 mA
Off-state current	I_r	≤ 800 μ A
Switching state indicator		LED, red
Mag. Field strength, AC fields		250 mT
Mag. Field strength, DC fields		250 mT

Ambient conditions

Ambient temperature	-25 ... 70 °C (-13 ... 158 °F)
---------------------	--------------------------------

Mechanical specifications

Connection type	300 mm POC cable with 3-pin, M12 x 1 connector
Core cross-section	0.34 mm ²
Housing material	Xylan coated - Stainless steel 1.4305 / AISI 303
Sensing face	Xylan coated - Stainless steel 1.4305 / AISI 303
Degree of protection	IP67 / IP68 / IP69K - cordset dependent according to cable specification

Compliance with standards and directives

Standard conformity	
Standards	EN 60947-5-2:2007 IEC 60947-5-2:2007

Approvals and certificates

UL approval	cULus Listed, General Purpose
CSA approval	cCSAus Listed, General Purpose
CCC approval	CCC approval / marking not required for products rated ≤ 36 V

Dimensions

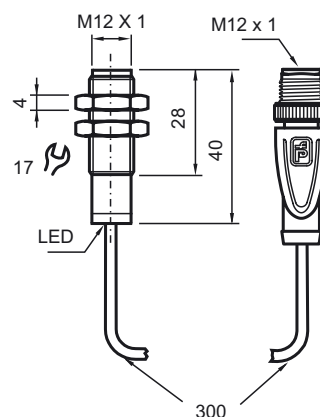

Electrical Connection

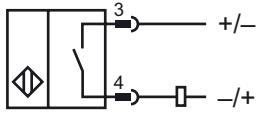

Pinout

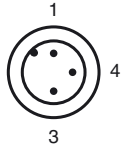

Wire colors in accordance with EN 60947-5-2

1		BN	(brown)
3		BU	(blue)
4		BK	(black)