

LK1023

LK0472B-B-00KQPKG/US

Level sensors

Technical note: PDF

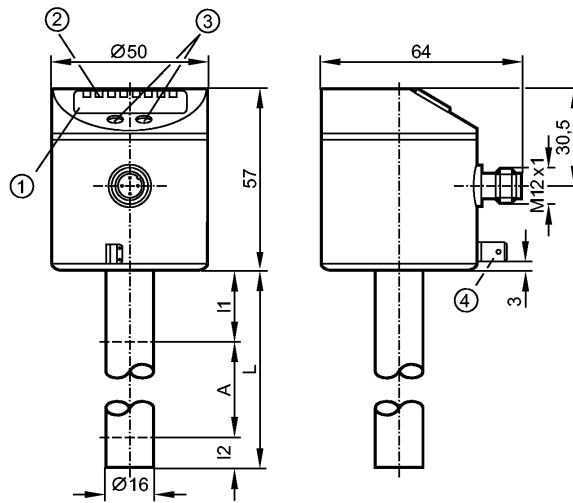

- 1: 4-digit alphanumeric display
- 2: status LEDs
- 3: Programming buttons
- 4: Housing connection (flat-pin connector 6.3 mm following DIN 46244)



Product characteristics

Electronic level sensor

Quick disconnect

Probe length: L = 472 mm

2 switching outputs

4-digit alphanumeric display

Application

Application	Hydrous coolants, oils, water, media similar to water
Cannot be used for:	extremely conductive and adhering media, granulates and bulk materials, acids and alkalis, food and electroplating applications
Dielectric constant medium	> 2
Medium temperature oil	
- Continuous [°C]	0...70
- Short time [°C]	0...90
Medium temperature water and hydrous media [°C]	0...35 (LK1023 + E43101: 0...60) **)
Medium temperature coolant emulsions [°C]	0...35 (LK1023 + E43101: 0...60) **)
Maximum speed of the change of level [mm/s]	200

Electrical data

Electrical design	DC PNP
Operating voltage [V]	18...30 DC
Current consumption [mA]	< 60
Protection class	III
Reverse polarity protection	yes

Outputs

Output	2 switching outputs
--------	---------------------

LK1023

LK0472B-B-00KQPKG/US

Level sensors

Output function		2 x normally open / closed programmable
Current rating	[mA]	200
Voltage drop	[V]	< 2.5
Short-circuit protection		thermal, pulsed
Overload protection		yes

Measuring / setting range		
Probe length L	[mm]	472
Active range A	[mm]	390
Inactive range I1 / I2	[mm]	53 / 30
Setting range		
Set point, SP	[mm]	40...395
Reset point, rP	[mm]	35...390
in steps of	[mm]	5
Hysteresis	[mm]	5
Overflow prevention OP	[mm]	139 - 163 - 188 - 212 - 236 - 261 - 285 - 310 - 334 - 358 - 383 - 407
Hysteresis OP	[mm]	3

Accuracy / deviations		
Deviations (% of value of measuring range)		
Switch point accuracy		± 5
Repeatability		± 2

Reaction times		
Power-on delay time	[s]	3

Software / programming		
Programming options		hysteresis / window function; N.O. / N.C; position of SP/rP; position of OP; OP adjustment; medium adjustment; offset; display unit

Environment		
Ambient temperature	[°C]	0...60
Storage temperature	[°C]	-25...80
Maximum vessel pressure	[bar]	0.5 (mounted with mounting accessories E43001 - E43007)
Protection		IP 67

Tests / approvals		
EMC	EN 61000-4-2 ESD:	4 kV CD / 8 kV AD
	EN 61000-4-3 HF radiated:	10 V/m
	EN 61000-4-4 Burst:	2 kV
	EN 61000-4-6 HF conducted:	10 V
Shock resistance	DIN EN 60068-2-29:	15 g (11 ms)
Vibration resistance	DIN EN 60068-2-6	5 g (10...2000 Hz)
MTTF	[Years]	265

Mechanical data		
Materials (wetted parts)		PP
Housing materials		stainless steel (304S15); FKM; NBR; PBT; PC; PEI; PP; TPE / V
Weight	[kg]	0.405

Displays / operating elements		
Display		Display unit / status 2 x LED green Switching status 2 x LED yellow Measured values 4-digit alphanumeric display

LK1023

LK0472B-B-00KQPKG/US

Level sensors

Programming 4-digit alphanumeric display

Electrical connection

Connection M12 connector (according to EN 61076-2-101); gold-plated contacts

Wiring

Programming of the output function:
 Hno = hysteresis / normally open
 Hnc = hysteresis / normally closed
 Fno = window function / normally open
 Fnc = window function / normally closed

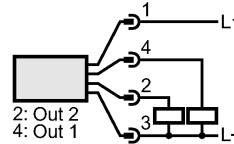

Remarks

Remarks cULus - Class 2 source required
 **) for water and hydrous media with temperatures > 35 °C install the unit into a climatic tube (order no. E43101)

Pack quantity [piece] 1

Technical note: PDF