



Model Number

IPC11-30

Data carrier

Features

- Battery-free data carrier
- 40 bit fixcode free programmable
- Readable from both sides
- Mounting holes for simple installation
- Protection degree IP67

Dimensions

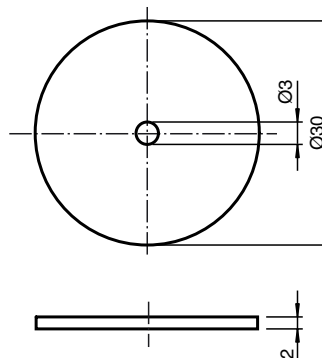

Technical data

General specifications

Operating frequency	125 kHz
Transfer rate	2 kBit/s

Memory

Chip Type	Q5
Type/Size	EEPROM 40 bit fixcode free programmable
Read cycles	unlimited

Ambient conditions

Ambient temperature	-25 ... 70 °C (-13 ... 158 °F)
Storage temperature	-40 ... 85 °C (-40 ... 185 °F)

Mechanical specifications

Protection degree	IP67
Material	
Housing	PC (Polycarbonate)

Compliance with standards and directives

Standard conformity	
Protection degree	EN 60529

Notes

The transponder can be read and written from either side.