

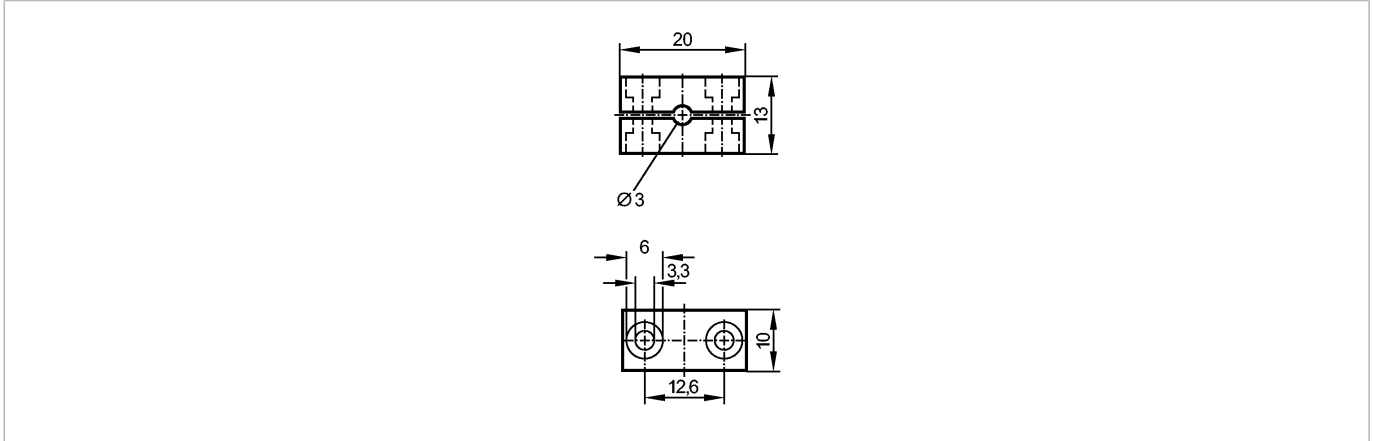

MOUNTING CLAMP 3 MM

Accessories



Product characteristics

Mounting clamp

Ø 3 mm

Mechanical data

Design

for fibre optics

Housing materials

aluminum black anodized

Weight [kg]

0.019

Accessories

Accessories (included)

2 mounting screws; M3 x 16

Remarks

Pack quantity [piece]

1