

no longer available - archive entryreplaced by: EVC151

ecomat 400

E18227



Connection technology

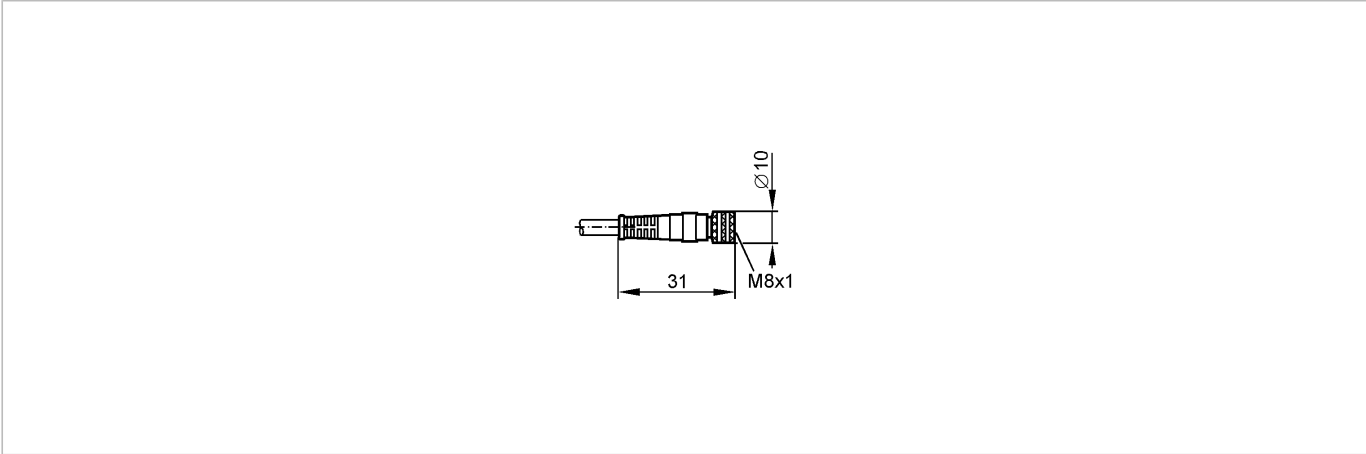

Product characteristics

Socket

For sensors with

M8 connector

gold-plated contacts

Electrical data

Electrical design

AC/DC

Operating voltage [V]

60 AC / 75 DC

Protection class

III

Environment

Ambient temperature [°C]

-20...80

Protection

IP 68

Mechanical data

Design

straight

Material body

TPE black

Material nut

brass; nickel-plated

Electrical connection

Connection

PUR cable / 5 m; 4 x AWG 24 (4 x 0.25 mm²); Ø 5 mm

Sheath color

black

Wiring

Core colors

BK black

BN brown

BU blue

WH white

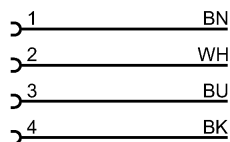

Remarks

Pack quantity

[piece]

1

ifm efector, inc. • 1100 Atwater Drive • Malvern • PA 19355 — We reserve the right to make technical alterations without prior notice. — US — E18227 — 01.09.2008

no longer available - archive entryreplaced by: EVC151