

no longer available - archive entry replaced by: EVC005

ecomat 400

E18008



Connection technology

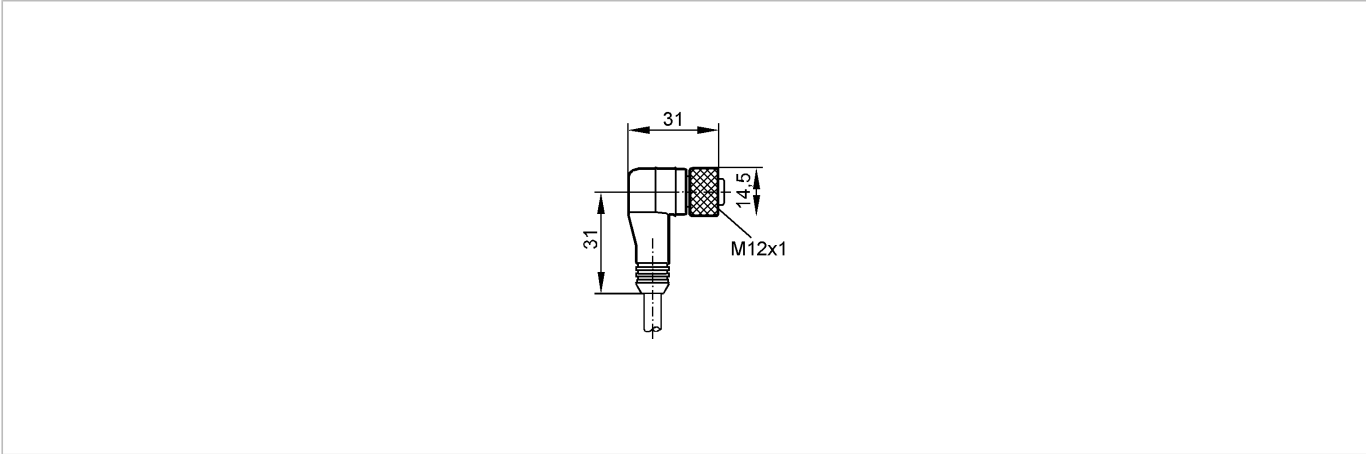

Product characteristics

Socket

For sensors with

M12 connector

gold-plated contacts

Electrical data

Electrical design

AC/DC

Operating voltage [V]

300 AC/DC

Environment

Ambient temperature [°C]

-20...105

Protection

IP 68

Mechanical data

Design

angled

Material body

TPE

Material nut

brass; nickel-plated

Electrical connection

Connection

TPE-S cable / 5 m; 4 x AWG 22 (4 x 0.34 mm²)

Sheath color

black

Wiring

Core colors

BK black

BN brown

BU blue

WH white

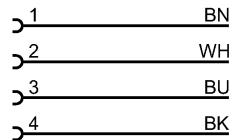

Remarks

Pack quantity

[piece]

1

ifm efector, inc. • 1100 Atwater Drive • Malvern • PA 19355 — We reserve the right to make technical alterations without prior notice. — US — E18008 — 08.04.2016

no longer available - archive entry replaced by: EVC005