

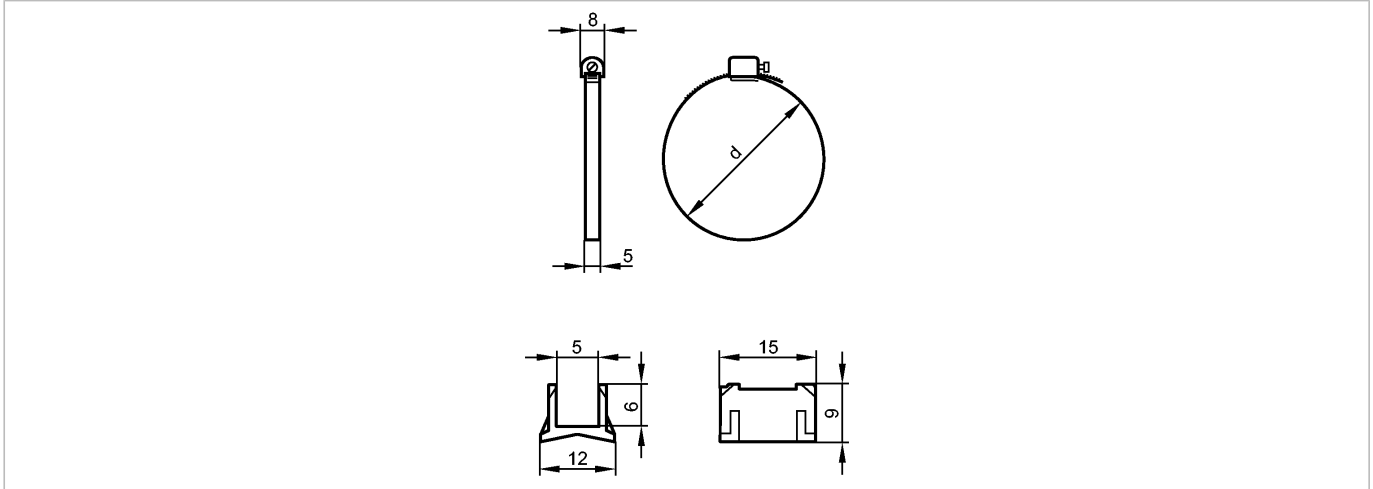

FIXING STRAP CLEAN-LINE CYL

Accessories



Product characteristics

Fixing strap for smooth body cylinders

Ø 63 mm

Piston diameter

Mechanical data

Design

for types MKT

Housing materials

adapter: PA (polyamide); Fixing strap: stainless steel (303S22)

Piston diameter [mm]

63

Weight [kg]

0.008

Clamping range d [mm]

58...69

Accessories

Accessories (included)

adapter for types MKT

Remarks

Pack quantity [piece]

1