

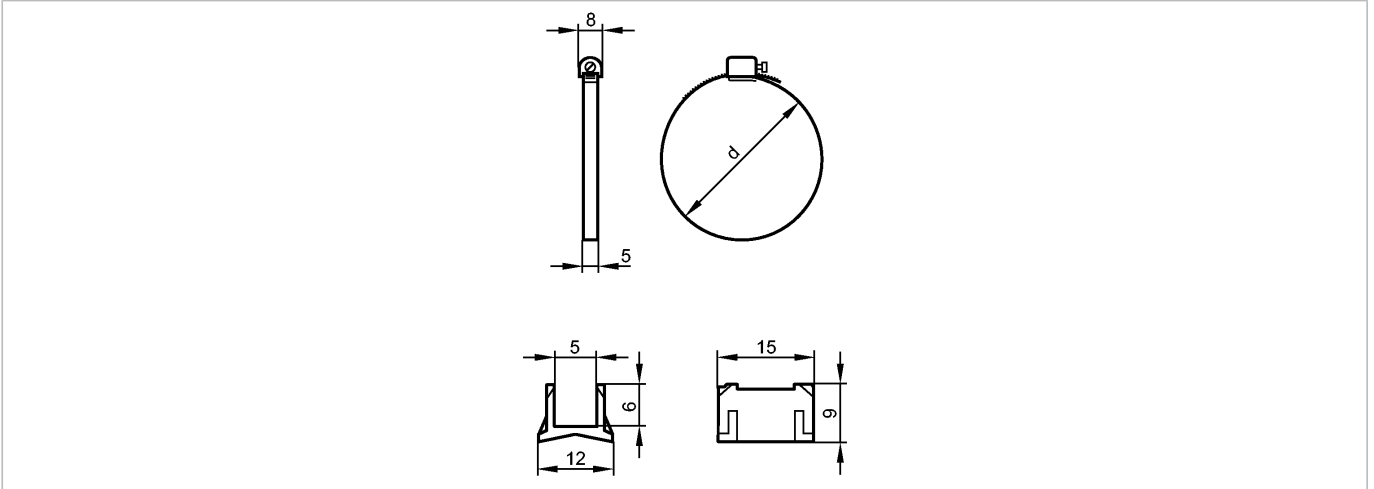

FIXING STRAP CLEAN-LINE CYL

Accessories



Product characteristics

Fixing strap for smooth body cylinders

Ø 40 mm

Piston diameter

Mechanical data

Design

for types MKT

Housing materials

adapter: PA (polyamide); Fixing strap: stainless steel (303S22)

Piston diameter [mm]

40

Weight [kg]

0.007

Clamping range d [mm]

38...49

Accessories

Accessories (included)

adapter for types MKT

Remarks

Pack quantity [piece]

1