

no longer available - archive entryAlternative article: EVC432

When selecting an alternative article and accessories please note that technical data may differ!

ecomat 400

E11763



YDOGH040MSS0002H04STGH050MSS

Connection technology

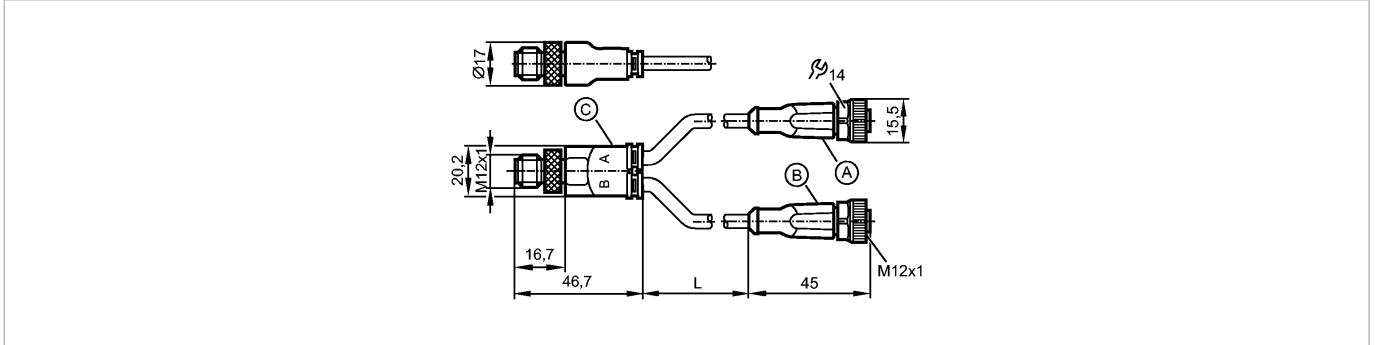

Product characteristics

Y connection cable

M12-plug / 2 x M12-socket

Free from silicone

Free from halogen

gold-plated contacts

Electrical data

Electrical design

Operating voltage

[V]

DC

250 AC / 300 DC

Environment

Ambient temperature

[°C]

-25...90

Protection

IP 68

Mechanical data

Design

2 way

Material body

housing connector: TPU (urethane) black; housing socket: TPU (urethane) orange;
sealing: Vitalon

Material nut

brass; nickel-plated

Weight

[kg]

0.173

Electrical connection

Connection

PUR cable / 2 m;

5 x 0.34 mm² (42 x Ø 0.1 mm); Ø 4.9 mm; halogen-free

Sheath color

black

Wiring

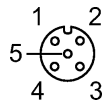
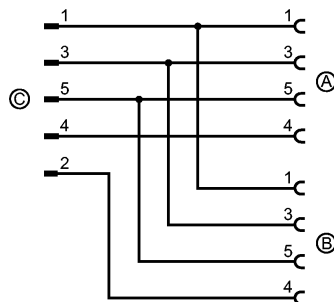
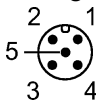

Remarks

Pack quantity

[piece]

1

ifm efector, inc. • 1100 Atwater Drive • Malvern • PA 19355 — We reserve the right to make technical alterations without prior notice. — US — E11763 — 05.04.2012

no longer available - archive entryAlternative article: EVC432

When selecting an alternative article and accessories please note that technical data may differ!