

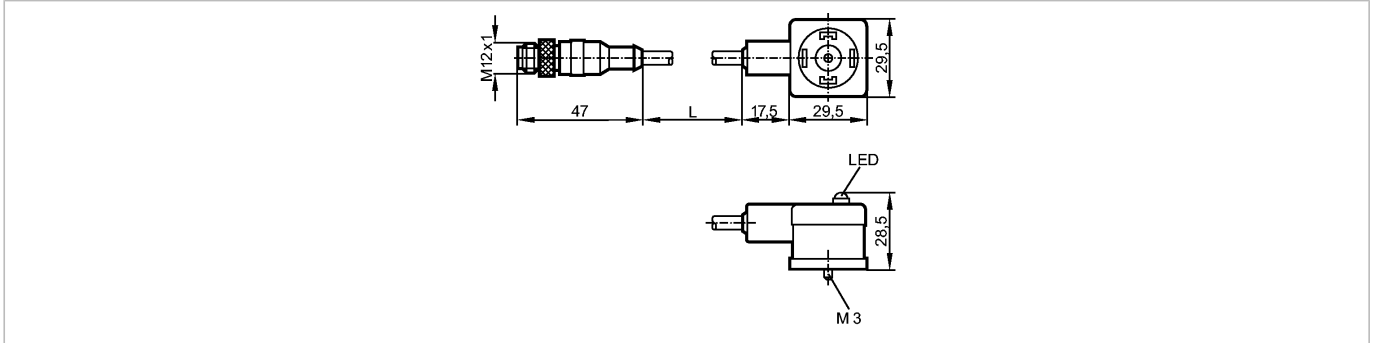

VVDAA031MSS0005H03STGH030MSS

Connection technology



Product characteristics

Patchcords

M12 plug / valve plug type A (according to DIN EN 175301-803)

Free from silicone

Free from halogen

with protective circuitry

Electrical data

Electrical design

Operating voltage [V]

AC/DC

24 AC/DC

Current rating [A]

3

Overvoltage protection VDR

•

Environment

Ambient temperature [°C]

-25...80

Protection

IP 67

Mechanical data

Design

straight / angled

Material body

PUR

Material nut

brass; nickel-plated

Tightening torque for knurled nut [Nm]

0.7...0.9

Weight [kg]

0.27

Displays / operating elements

Output status indication LED

yellow

Electrical connection

Connection

PUR cable / 5 m;

3 x 0.5 mm² (42 x Ø 0.1 mm); Ø 5 mm; halogen-free, M12-plug contacts: gold-plated, valve plug contacts: nickel-plated brass

Sheath color

black

Wiring

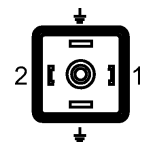
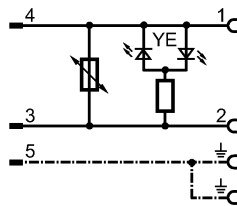

Accessories

Accessories (included)

screw; tag for labelling

Remarks

Pack quantity [piece]

1