

no longer available - archive entry

ecomat 400

E11342



VDOGH030MSS0005H03STGF030MSS

Connection technology

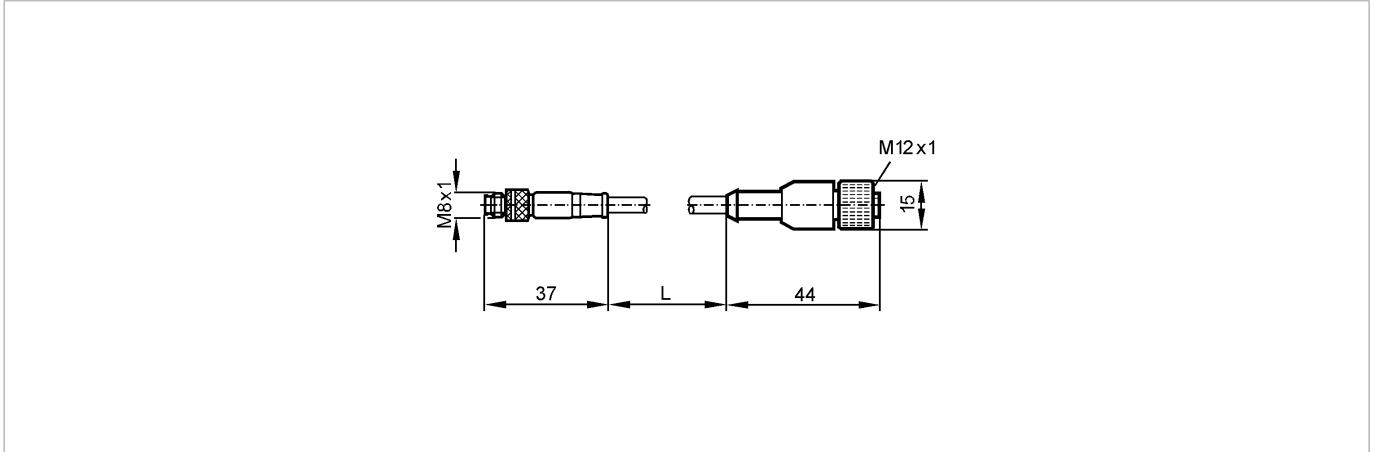

Product characteristics

Patchcords

M8-plug / M12-socket

Free from silicone

Free from halogen

gold-plated contacts

Electrical data

Electrical design

Operating voltage [V]

Current rating [A]

Protection class

Environment

Ambient temperature [°C]

Protection

Mechanical data

Design

Material body

Material nut

Tightening torque for knurled nut [Nm]

Weight [kg]

Electrical connection

Connection

Sheath color

AC/DC

60 AC / 75 DC

3

III

-25...85

IP 68

straight / straight

PUR

brass; nickel-plated

plug: 0.6...0.7 / socket: 0.7...0.9

0.135

PUR cable / 5 m;

3 x 0.34 mm² (42 x Ø 0.1 mm); Ø 5 mm; halogen-free

black

Wiring

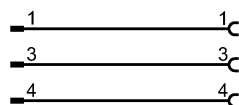
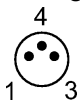

Remarks

Pack quantity

[piece]

1

ifm efector, inc. • 1100 Atwater Drive • Malvern • PA 19355 — We reserve the right to make technical alterations without prior notice. — US — E11342 — 13.01.2017

no longer available - archive entry