

MOUNTING CLAMP M12

Accessories

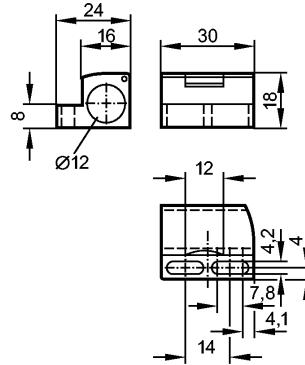

Product characteristics

Mounting clamp

Ø 12 mm

Environment

Ambient temperature [°C] -25...85

Mechanical data

Design with end stop for types M12

Housing materials

PC

Weight

[kg]

0.008

Remarks

Pack quantity

[piece]

1