

no longer available - archive entry replaced by: EBC023

ecomat 400

E10282



ZDO8H059MSS0005H11

Connection technology

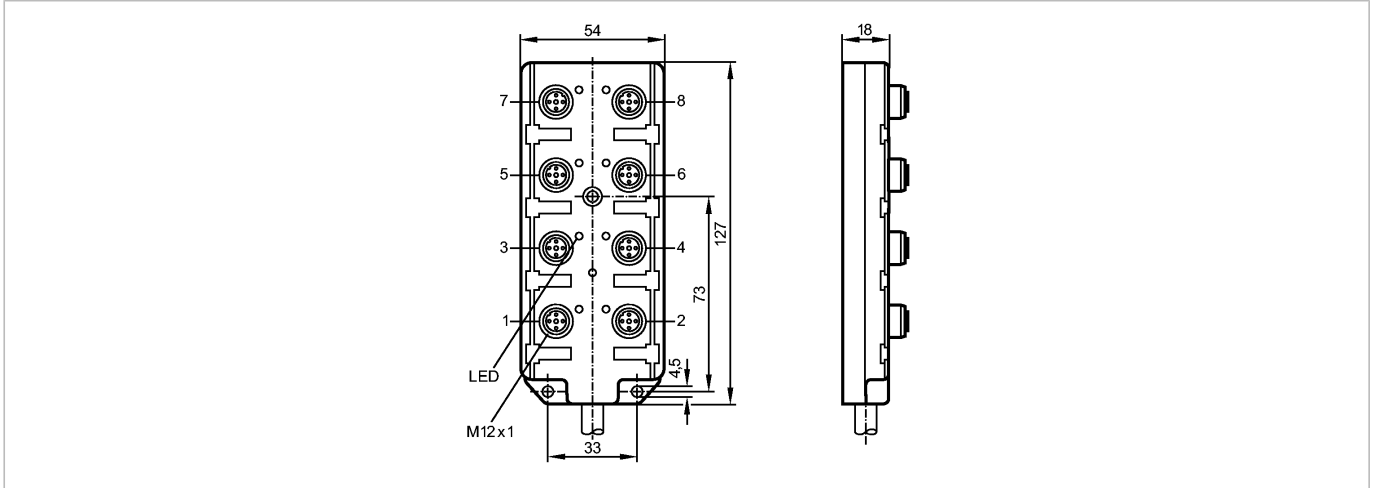

Product characteristics

Wiring block

Cable

Free from halogen

Free from silicone

gold-plated contacts

Electrical data

Electrical design

Operating voltage [V]

Max. total current load [A]

Max. current load per location [A]

Protection class

Environment

Ambient temperature [°C]

Protection

Mechanical data

Design

Housing materials

Tightening torque for knurled nut [Nm]

Weight [kg]

Displays / operating elements

Output status indication LED

Power LED

Electrical connection

Connection

Sheath color

Wiring

DC

10...30 DC

12

4

II

-15...80

IP 67

8 way

TPU (urethane)

0.5

0.663

8 x yellow

green

PUR cable / 5 m;

8 x 0.34 mm² (43 x Ø 0.1 mm) + 3 x 0.75 mm² (95 x Ø 0.1 mm); Ø 9 mm; halogen-free

black

E10282 - Wiring block - eclass: 27279201 / 27-27-92-01

- Core colors
- BK black
 - BN brown
 - BU blue
 - GN green
 - GN/YE green/yellow
 - GY grey
 - PK pink
 - RD red
 - VT lilac
 - WH white
 - YE yellow

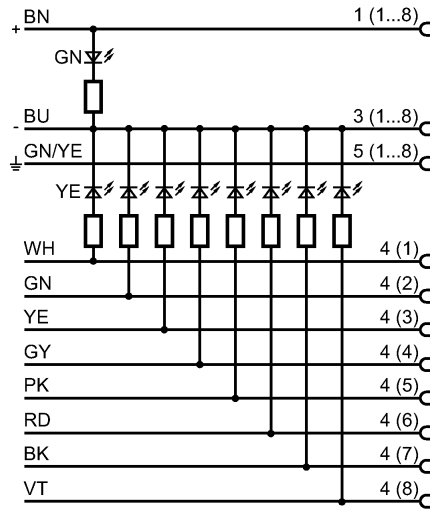
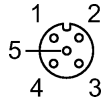

Remarks

Pack quantity [piece] 1

Other data

Ports M12

ifm efector, inc. • 1100 Atwater Drive • Malvern • PA 19355 — We reserve the right to make technical alterations without prior notice. — US — E10282 — 20.09.2010
no longer available - archive entryreplaced by: EBC023