

no longer available - archive entry replaced by: EBC019

ecomat 400

E10280



ZDO6H057MSS0005H09

Connection technology

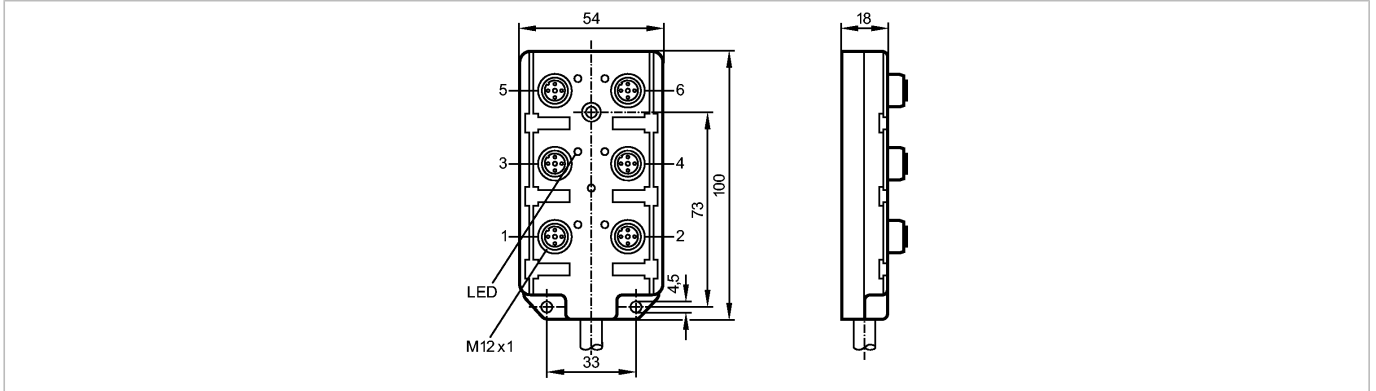

Product characteristics

Wiring block

Cable

Free from halogen

Free from silicone

gold-plated contacts

Electrical data

Electrical design

Operating voltage [V]

Max. total current load [A]

Max. current load per location [A]

Protection class

Environment

Ambient temperature [°C]

Protection

Mechanical data

Design

Housing materials

Tightening torque for knurled nut [Nm]

Weight [kg]

Displays / operating elements

Output status indication LED

Power LED

Electrical connection

Connection

Sheath color

Wiring

Core colors

BN brown

BU blue

GN green

GN/YE green/yellow

GY grey

PK pink

RD red

WH white

YE yellow

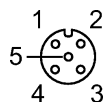

	DC
Operating voltage [V]	10...30 DC
Max. total current load [A]	12
Max. current load per location [A]	4
Protection class	II
Ambient temperature [°C]	-15...80
Protection	IP 67
Design	6 way
Housing materials	TPU (urethane)
Tightening torque for knurled nut [Nm]	0.5
Weight [kg]	0.566
Output status indication LED	6 x yellow
Power LED	green
Connection	PUR cable / 5 m; 6 x 0.34 mm ² (43 x Ø 0.1 mm) + 3 x 0.75 mm ² (95 x Ø 0.1 mm); Ø 9 mm; halogen-free black

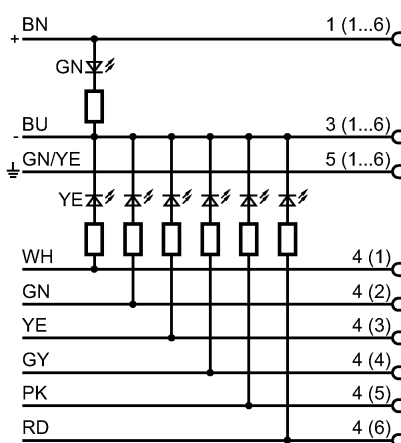

E10280 - Wiring block - eclass: 27279201 / 27-27-92-01

Remarks

Pack quantity	[piece]	1
---------------	---------	---

Other data

Ports	M12
-------	-----

ifm efector, inc. • 1100 Atwater Drive • Malvern • PA 19355 — We reserve the right to make technical alterations without prior notice. — US — E10280 — 06.03.2003
no longer available - archive entryreplaced by: EBC019