

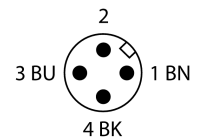

- Threaded barrel, M18 x 1
- Chrome-plated brass
- Factor 1 for all metals
- Resistant to magnetic fields
- Extended temperature range
- High switching frequency
- DC 3-wire, 10...30 VDC
- NO contact, NPN output
- M12 x 1 male connector

Wiring Diagram

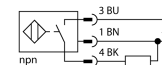

Functional principle

Inductive sensors detect metal objects contactless and wear-free. *uprox®* Factor 1 sensors have significant advantages due to their patented ferrite-coreless multicoil system. They detect all metals at the same large switching distance and are resistant to magnetic fields.

Type designation	BI5U-M18-AN6X-H1141
Ident no.	1635150
Rated switching distance Sn	5 mm
Mounting conditions	Flush
Secured operating distance	≤ (0,81 x Sn) mm
Repeat accuracy	≤ 2 % of full scale
Temperature drift	≤ ± 10 %
Hysteresis	≤ ± 15 %, ≤ -25 °C v ≥ +70 °C
Ambient temperature	3...15 % -30...+85 °C
Operating voltage	10...30 VDC
Residual ripple	≤ 10 % U _{ss}
DC rated operational current	≤ 200 mA
No-load current I ₀	≤ 20 mA
Residual current	≤ 0.1 mA
Isolation test voltage	≤ 0.5 kV
Short-circuit protection	yes/ Cyclic
Voltage drop at I ₀	≤ 1.8 V
Wire breakage/Reverse polarity protection	yes/ Complete
Output function	3-wire, NO contact, NPN
Reverse polarity protection	Complete
Protection class	☐
Switching frequency	1.5 kHz
Design	Threaded barrel, M18 x 1
Dimensions	52 mm
Housing material	Metal, CuZn, Chrome-plated
Active area material	Plastic, PBT
Max. tightening torque housing nut	25 Nm
Electrical connection	Connector, M12 x 1
Vibration resistance	55 Hz (1 mm)
Shock resistance	30 g (11 ms)
Protection class	IP67
MTTF	874 years acc. to SN 29500 (Ed. 99) 40 °C
Switching state	LED yellow

Distance D	2 x B
Distance W	3 x Sn
Distance T	3 x B
Distance S	1.5 x B
Distance G	6 x Sn

Diameter active area B \varnothing 18 mm

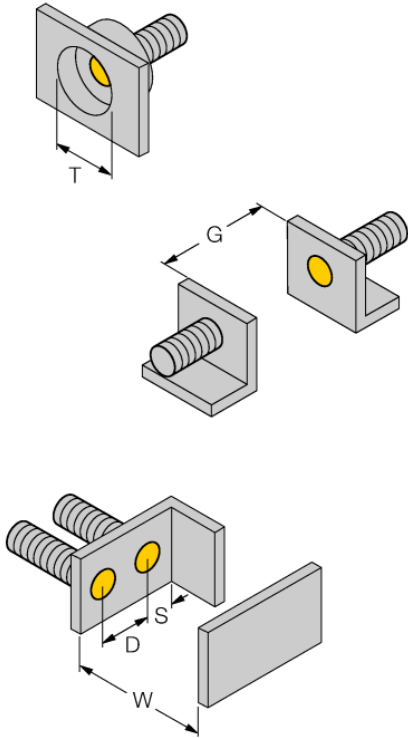

Accessories

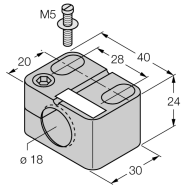
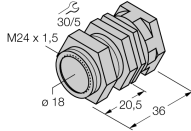
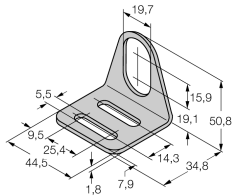
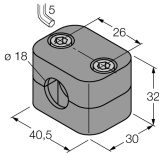
Type code	Ident no.	Description	
BST-18B	6947214	Fixing clamp for threaded barrel devices, with dead-stop; material: PA6	
QM-18	6945102	Quick-mount bracket with dead-stop; material: Chrome-plated brass Male thread M24 x 1.5. Note: The switching distance of proximity switches can be reduced by the use of quick-mount brackets.	
MW-18	6945004	Mounting bracket for threaded barrel devices; material: Stainless steel A2 1.4301 (AISI 304)	
BSS-18	6901320	Mounting bracket for smooth and threaded barrel devices; material: Polypropylene	

Wiring accessories

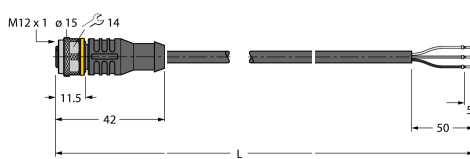
Type code	Ident no.	Description	
RKC4T-2/TEL	6625010	Connection cable, female M12, straight, 3-pin, cable length: 2 m, sheath material: PVC, black; cULus approval; other cable lengths and qualities available, see www.turck.com	

Edition • 2017-06-25T01:39:50+02:00