

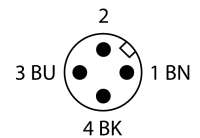

- Threaded barrel, M30 x 1.5
- Plastic, PBT-GF30
- Factor 1 for all metals
- Protection class IP68
- Resistant to magnetic fields
- Extended temperature range
- High switching frequency
- DC 3-wire, 10...30 VDC
- NO contact, PNP output
- M12 x 1 male connector

**Wiring Diagram**

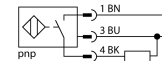

**Functional principle**

Inductive sensors detect metal objects contactless and wear-free. *uprox®* Factor 1 sensors have significant advantages due to their patented ferrite-coreless multicoil system. They detect all metals at the same large switching distance and are resistant to magnetic fields.

<b>Type designation</b>	BI10U-S30-AP6X-H1141
Ident no.	1636600
<b>Rated switching distance Sn</b>	10 mm
Mounting conditions	Flush
Secured operating distance	≤ (0,81 x Sn) mm
Repeat accuracy	≤ 2 % of full scale
Temperature drift	≤ ± 10 %
Hysteresis	≤ ± 15 %, ≤ -25 °C v ≥ +70 °C
Ambient temperature	3...15 % -30...+85 °C
<b>Operating voltage</b>	10...30 VDC
Residual ripple	≤ 10 % U <sub>ss</sub>
DC rated operational current	≤ 200 mA
No-load current I <sub>0</sub>	≤ 20 mA
Residual current	≤ 0.1 mA
Isolation test voltage	≤ 0.5 kV
Short-circuit protection	yes/ Cyclic
Voltage drop at I <sub>0</sub>	≤ 1.8 V
Wire breakage/Reverse polarity protection	yes/ Complete
Output function	3-wire, NO contact, PNP
Reverse polarity protection	Complete
Protection class	☐
Switching frequency	2 kHz
<b>Design</b>	Threaded barrel, M30 × 1.5
Dimensions	62 mm
Housing material	Plastic, PBT-GF30
Active area material	Plastic, PA12-GF30
Max. tightening torque housing nut	5 Nm
Electrical connection	Connector, M12 × 1
Vibration resistance	55 Hz (1 mm)
Shock resistance	30 g (11 ms)
Protection class	IP68
MTTF	874 years acc. to SN 29500 (Ed. 99) 40 °C
<b>Switching state</b>	LED yellow

---

Distance D	2 x B
Distance W	3 x Sn
Distance T	3 x B
Distance S	1.5 x B
Distance G	6 x Sn

---

Diameter active area B                     $\varnothing$  30 mm

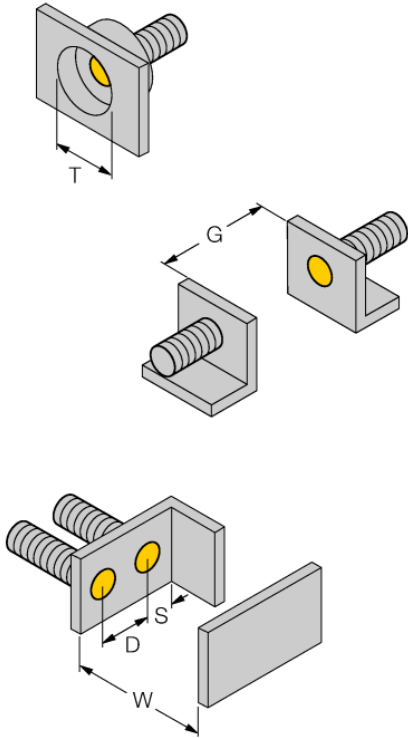

**Accessories**

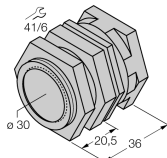
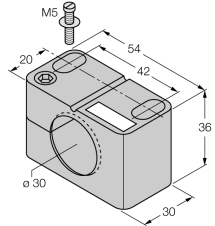
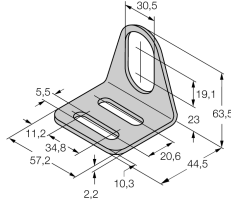
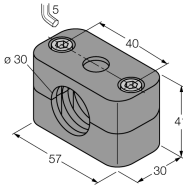
Type code	Ident no.	Description	
QM-30	6945103	Quick-mount bracket with dead-stop; material: Chrome-plated brass Male thread M36 x 1.5. Note: The switching distance of proximity switches can be reduced by the use of quick-mount brackets.	
BST-30B	6947216	Fixing clamp for threaded barrel devices, with dead-stop; material: PA6	
MW-30	6945005	Mounting bracket for threaded barrel devices; material: Stainless steel A2 1.4301 (AISI 304)	
BSS-30	6901319	Mounting bracket for smooth and threaded barrel devices; material: Polypropylene	

**Wiring accessories**

Type code	Ident no.	Description	
RKC4T-2/TEL	6625010	Connection cable, female M12, straight, 3-pin, cable length: 2 m, sheath material: PVC, black; cULus approval; other cable lengths and qualities available, see <a href="http://www.turck.com">www.turck.com</a>	