



MODEL NUMBER

7E-43758-B3

PRODUCT LINE

GO™ Switch 70 Series STG

SPECIFICATIONS

Model	2.062" probe length
Contact Form	SPDT, no indication
Sensing Range	0.090" end sensing
Outlet Position	Side entry, 1/2" NPT conduit
Enclosure Material	Stainless steel, 3000 PSI
Area Classification	UL General Purpose
Wiring Option	PVC Cable - 6ft
Custom Field	

WIRING DIAGRAM

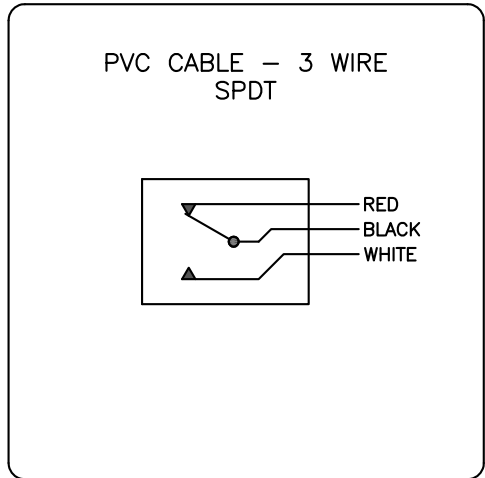

NAMEPLATE

Type 4X
 0°C ≤ Ta ≤ 40°C
 Conduit: 1/2 NPT
 0.5A @ 125VDC
 RATED 3,000 PSI
 PROBE 2.062" (52.37mm)



www.electrosupply.com
 sales@electrosupply.com
 1-800-663-6576