

74-13562-F3

GO™ Switch 70 Series Straight

Model	74 Model
Contact Form	SPDT
Sensing Range	0.100" end sensing
Outlet Position	Bottom of enclosure
Enclosure Material	316L SS, 2000 PSI
Area Classification	HiTemp, 400F
Wiring Option	Teflon leads, 6ft
Regional Certification	No Regional Certification
Custom Field	

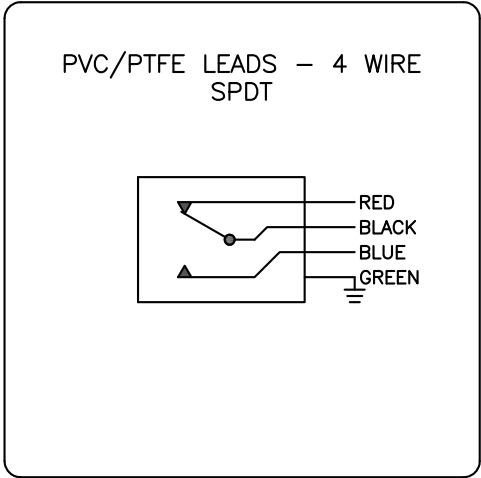
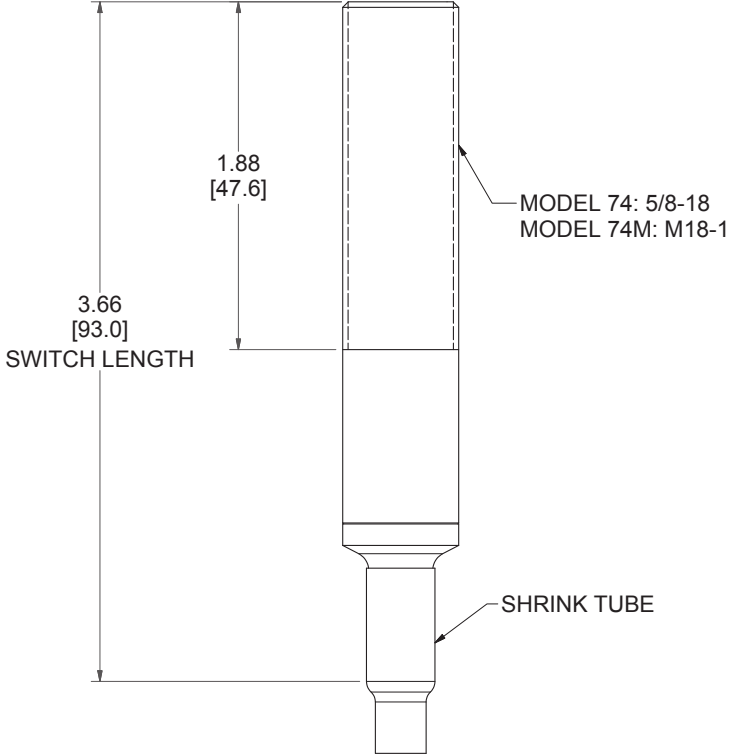

-40°C ≤ Ta ≤ 204°C;
120VAC/4A; 24VDC/3A



www.electrosupply.com
sales@electrosupply.com
1-800-663-6576