

71-16563-F2

GO™ Switch 70 Series Hex Head

Model	71 Model
Contact Form	SPDT
Sensing Range	0.040" end sensing
Outlet Position	Bottom of enclosure
Enclosure Material	316L Stainless Steel
Area Classification	UL CI I, Div 1
Wiring Option	HiTemp leads, Teflon, 3ft
Regional Certification	No Regional Certification
Custom Field	

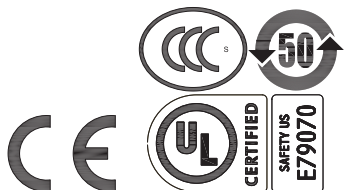
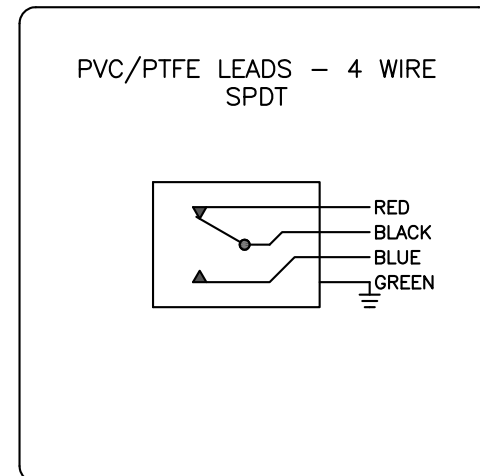

Class I, Division 1, Groups A,B,C,D; Type 4X
 Class II, Division 1, Groups E,F,G; Class III
 120VAC/4A; 24VDC/3A
 Conduit: 1/2 NPT - Lead Seal Required



www.electrosupply.com
 sales@electrosupply.com
 1-800-663-6576