

31-17544-A6

GO™ Switch Model 31

Model	31 Model
Contact Form	SPDT (Form C)
Sensing Range	Approx. 1/4" end sensing
Outlet Position	1/2"-14NPT conduit hub bottom
Enclosure Material	Stainless steel w/polyurethane
Area Classification	cUL Cl I Div 1
Wiring Options	50ft PVC lead wires
Regional Certification	No regional certification
Custom Field	

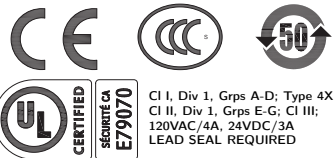
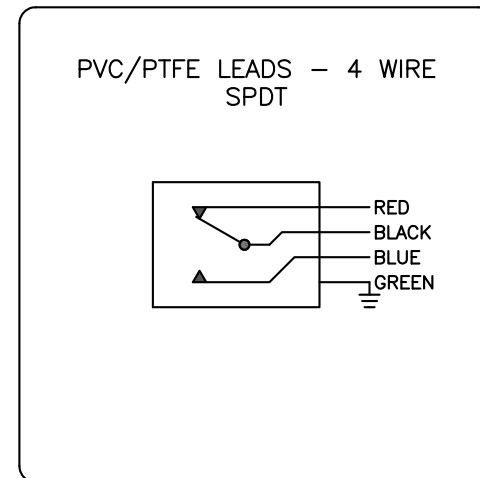

COUNTRY OF ORIGIN US

Model #:

Serial #:



www.electrosupply.com  
sales@electrosupply.com  
1-800-663-6576