

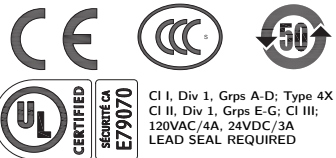

31-17524-A2

GO™ Switch Model 31

Model	31 Model
Contact Form	SPDT (Form C)
Sensing Range	Approx. 1/4" end sensing
Outlet Position	1/2"-14NPT conduit hub bottom
Enclosure Material	Stainless steel
Area Classification	cUL Cl I Div 1
Wiring Options	3ft PVC lead wires
Regional Certification	No regional certification
Custom Field	

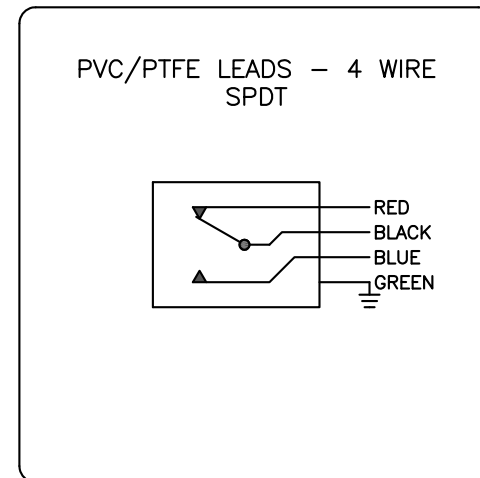

COUNTRY OF ORIGIN US

Model #:

Serial #:



www.electrosupply.com
sales@electrosupply.com
1-800-663-6576