

**MODEL NUMBER**

21-31520-00

**PRODUCT LINE**

GO™ Switch 10/20 Series

**SPECIFICATIONS**

Model	21 Model
Contact Form	SPDT (Form C) Latching
Sensing Range	Standard approx. 3/8" side
Outlet Position	Bottom of enclosure
Enclosure Material	Stainless steel
Area Classification	CSA/FM Cl I, Div 2
Wiring Options	Terminal block - 1/2" NPT
Regional Certification	No regional certification
Custom Field	

**WIRING DIAGRAM**

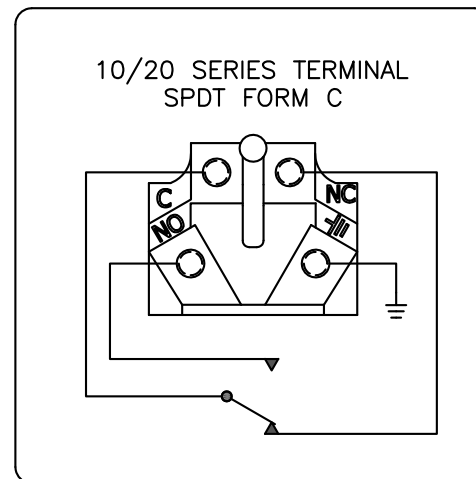

**NAMEPLATE**



CL I DIV 2, GRPS A,B,C,D; CL II DIV 1, GRPS E,F,G; CL III;  
 T<sub>1</sub>:T<sub>2</sub> - 50°C - T<sub>3</sub> - 60°C/90°C  
 ELECTRICAL RATING: 120VAC/10A, 24VDC/3A RESISTIVE; 480VAC/240VDC MAX  
 LEAD SEAL IS REQUIRED WITHIN 18" OF ENCLOSURE.  
 CAUTION: KEEP COVER TIGHT WHILE CIRCUITS ARE LIVE.

Model #: Serial #:



www.electrosupply.com  
 sales@electrosupply.com  
 1-800-663-6576