

21-11425-B3

GO™ Switch 10/20 Series

Model	21 Model
Contact Form	SPDT (Form C)
Sensing Range	Standard approx. 3/8" side
Outlet Position	Same side of sensing area
Enclosure Material	Stainless steel
Area Classification	Mine Safety Health Adm.
Wiring Options	6ft PVC cable
Regional Certification	No regional certification
Custom Field	

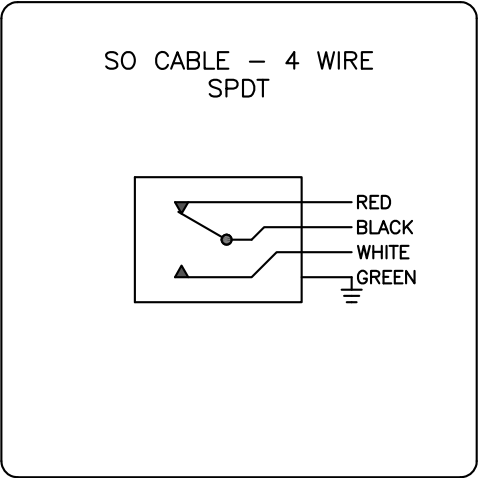
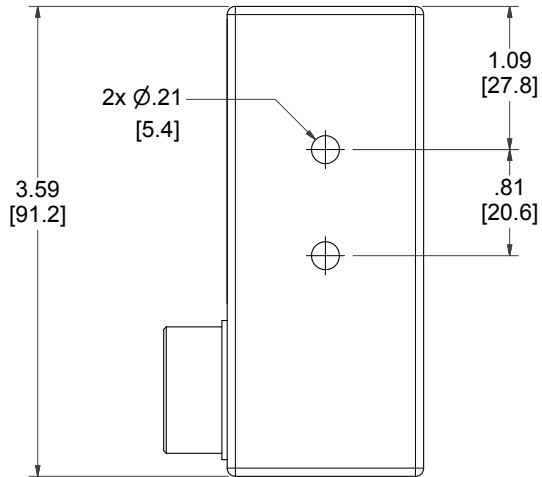
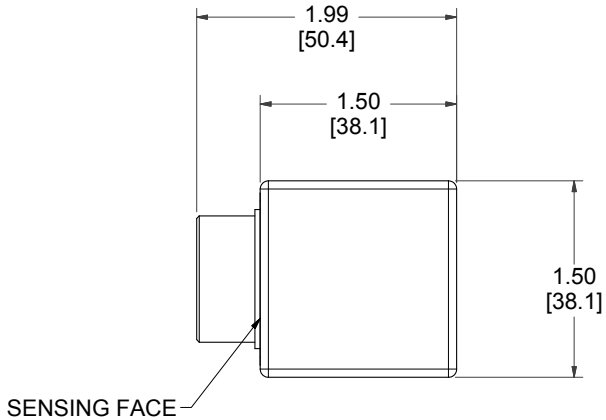

ELECTRICAL RATING: 120VAC/10A, 24VDC/3A RESISTIVE; 480VAC/240VDC MAX

Model #:

Serial #:



www.electrosupply.com
 sales@electrosupply.com
 1-800-663-6576