

**MODEL NUMBER**

21-11128-00

**PRODUCT LINE**

GO™ Switch 10/20 Series

**SPECIFICATIONS**

Model	21 Model
Contact Form	SPDT (Form C)
Sensing Range	Standard approx. 3/8" side
Outlet Position	Behind sensing area
Enclosure Material	Stainless steel
Area Classification	UL General Purpose
Wiring Options	Terminal block - 1/2" NPT
Regional Certification	No regional certification
Custom Field	

**WIRING DIAGRAM**

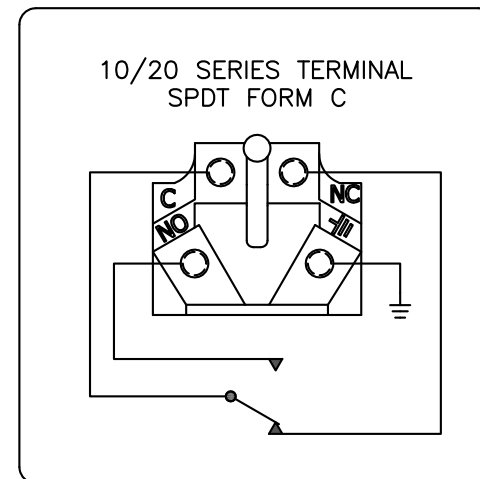

**NAMEPLATE**



TYPE 4X  
ELECTRICAL RATING: 120VAC/10A, 24VDC/3A RESISTIVE; 480VAC/240VDC MAX  
CAUTION: KEEP COVER TIGHT WHILE CIRCUITS ARE LIVE.

Model #:

Serial #:



www.electrosupply.com  
sales@electrosupply.com  
1-800-663-6576