

MODEL NUMBER

21-11118-00M

PRODUCT LINE

GO™ Switch 10/20 Series

SPECIFICATIONS

Model	21 Model
Contact Form	SPDT (Form C)
Sensing Range	Standard approx. 3/8" side
Outlet Position	Behind sensing area
Enclosure Material	Brass w/flat black lacquer
Area Classification	UL General Purpose
Wiring Options	Terminal block - M20 conduit
Regional Certification	No regional certification
Custom Field	

WIRING DIAGRAM

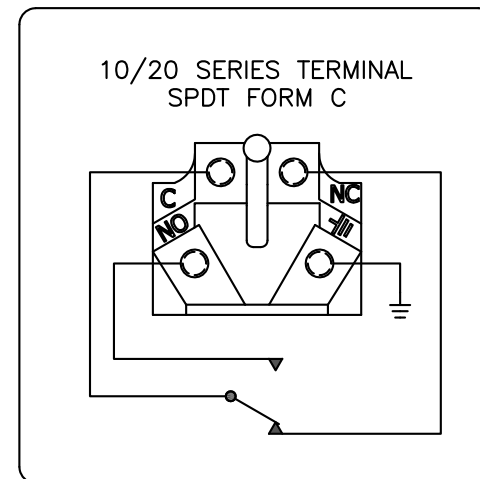

NAMEPLATE



TYPE 4X
ELECTRICAL RATING: 120VAC/10A, 24VDC/3A RESISTIVE; 480VAC/240VDC MAX
CAUTION: KEEP COVER TIGHT WHILE CIRCUITS ARE LIVE.

Model #:

Serial #:



www.electrosupply.com
sales@electrosupply.com
1-800-663-6576