

11-51123-A3

GO™ Switch 10/20 Series

Model	11 Model
Contact Form	DMDB, (Form Z)
Sensing Range	Standard approx. 3/8" side
Outlet Position	Behind sensing area
Enclosure Material	Stainless steel
Area Classification	UL CI I, Div 1
Wiring Options	6ft PVC lead wire
Regional Certification	No regional certification
Custom Field	

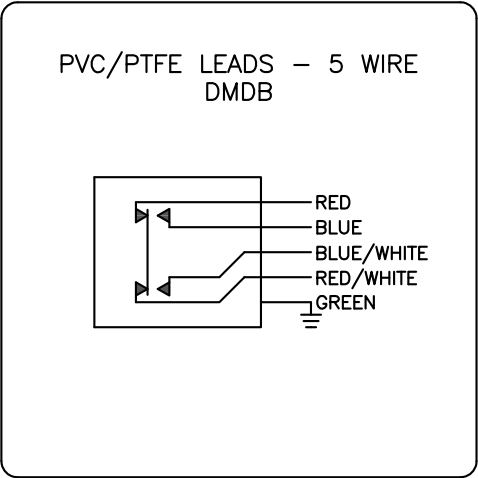
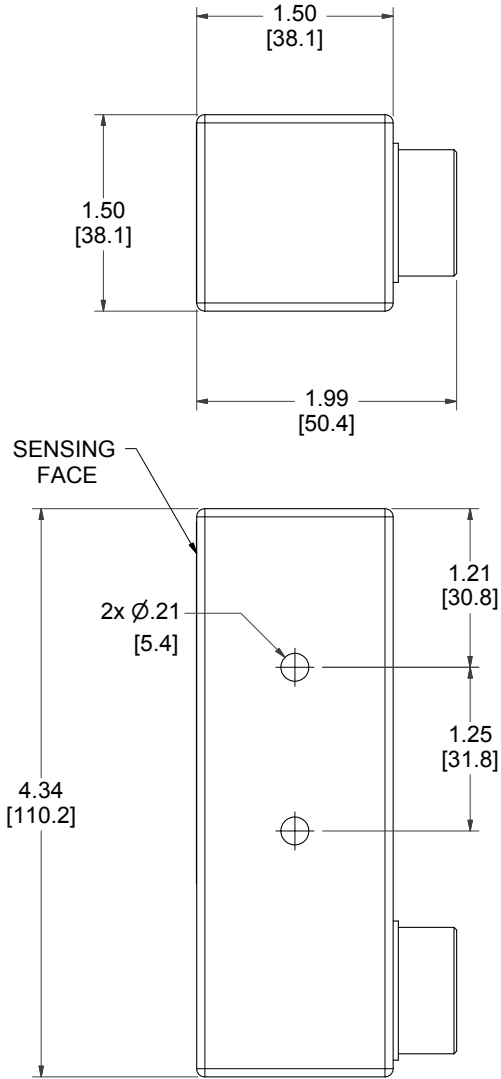

CL I DIV 1, GRP5 A,B,C,D; CL II DIV 1, GRP5 E,F,G; CL III, TYPE 4X
 ELECTRICAL RATING: 120VAC/10A, 240VDC/2A RESISTIVE; 480VAC/240VDC MAX
 STD. DUTY PILOT DUTY 120VAC; HEAVY DUTY PILOT DUTY 480VAC
 LEAD SEAL IS REQUIRED WITHIN 18" OF ENCLOSURE.

Model #:

Serial #:



www.electrosupply.com
 sales@electrosupply.com
 1-800-663-6576